

Sample

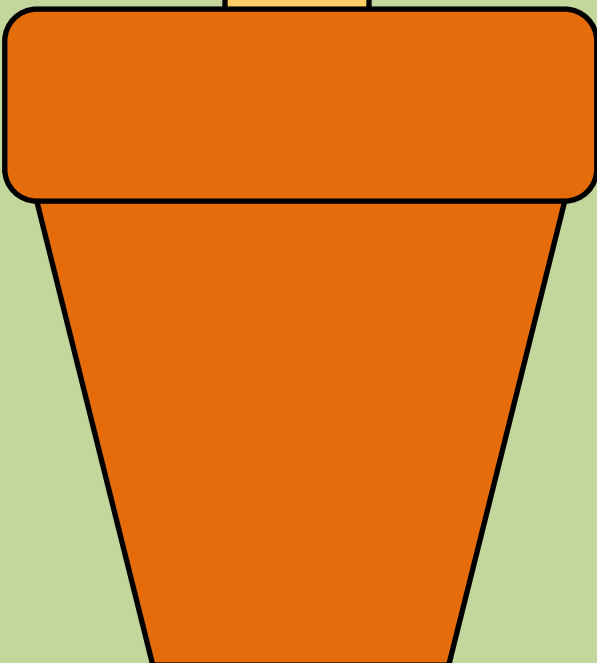

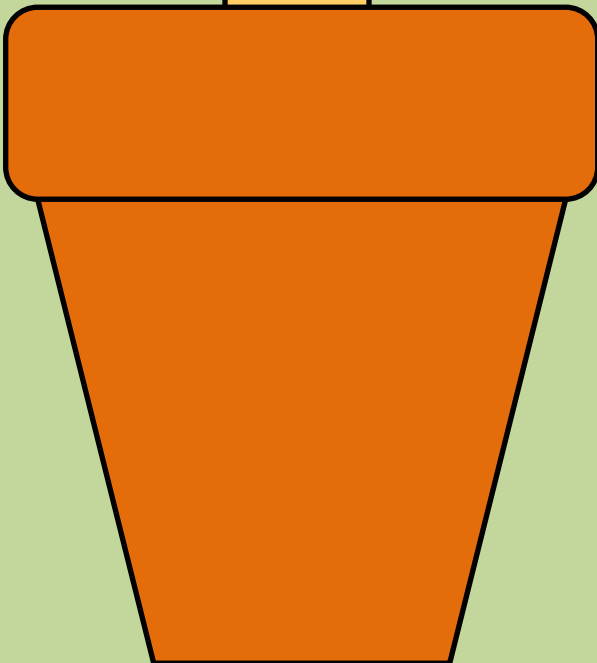

Set
of
6

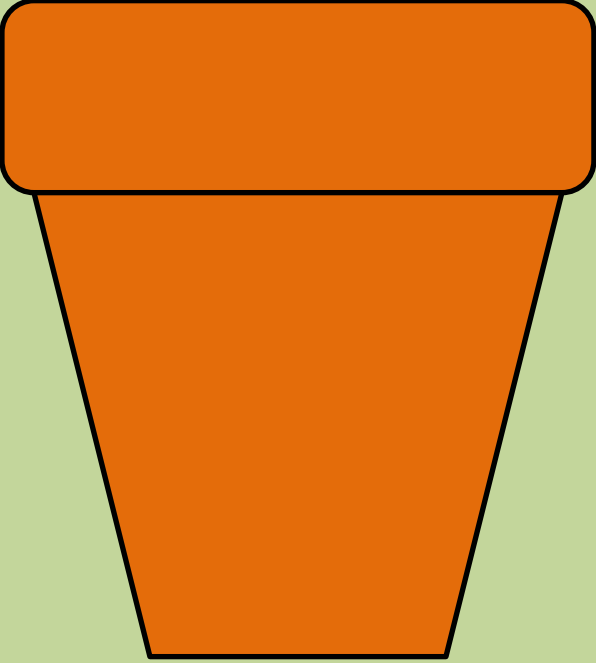
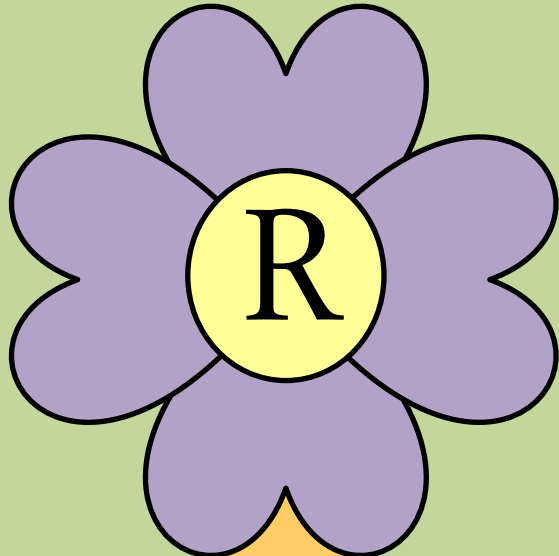
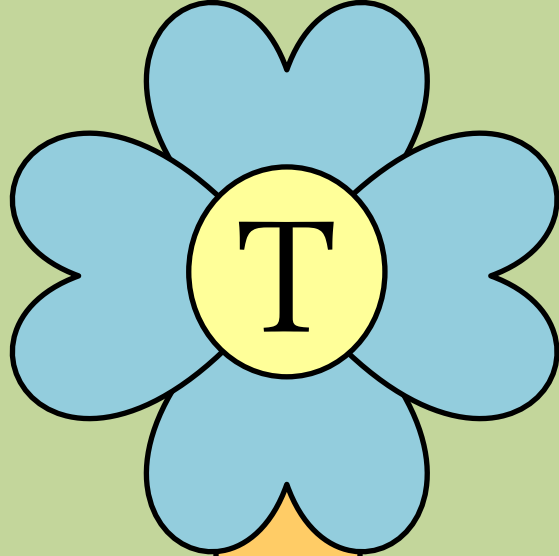
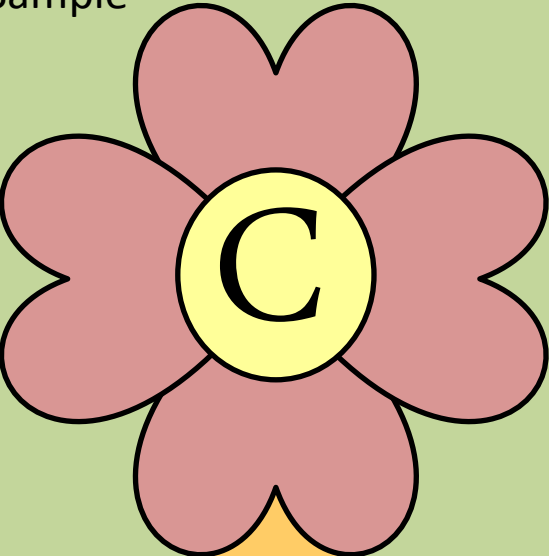
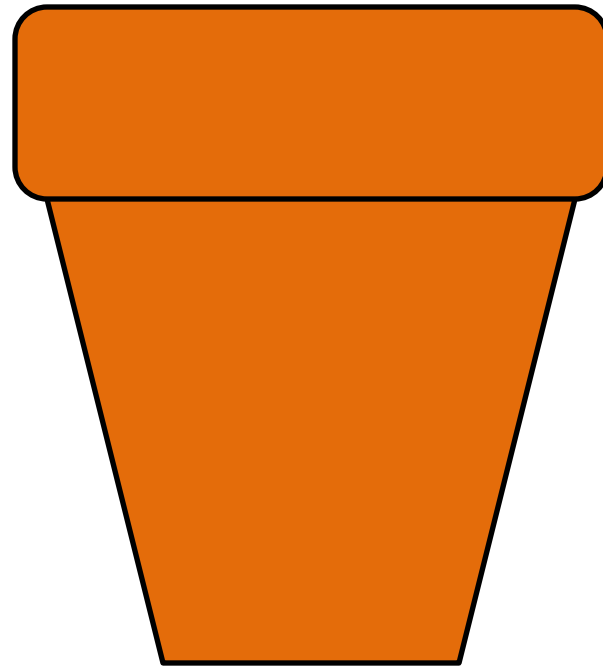
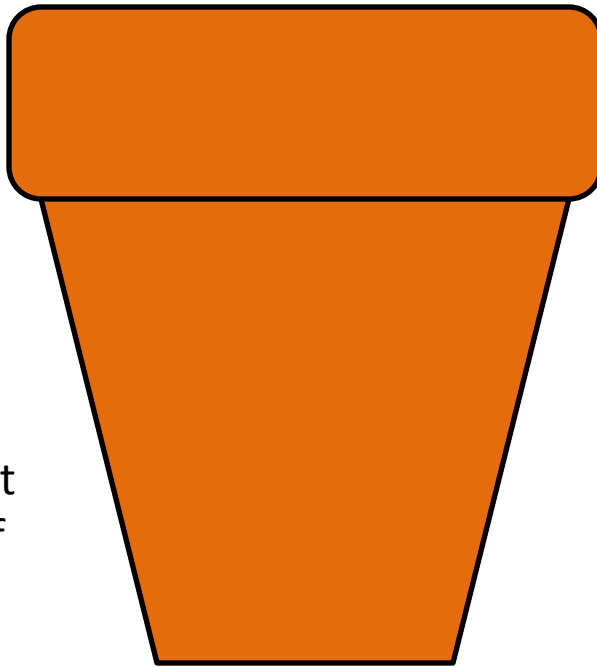
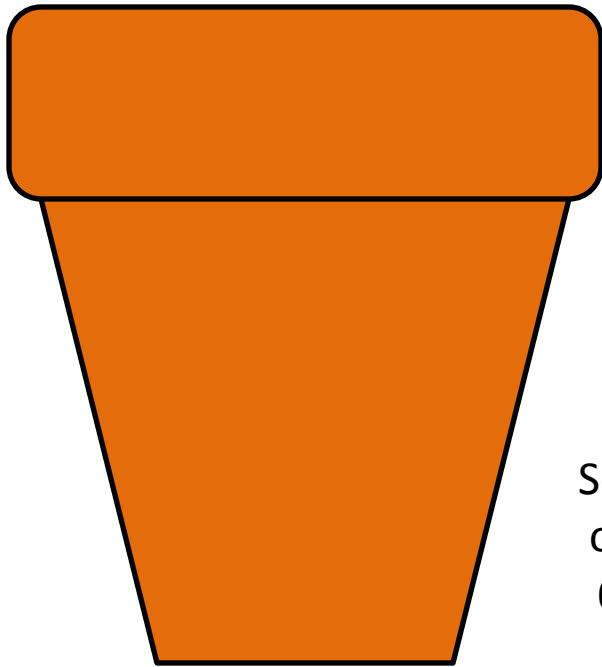
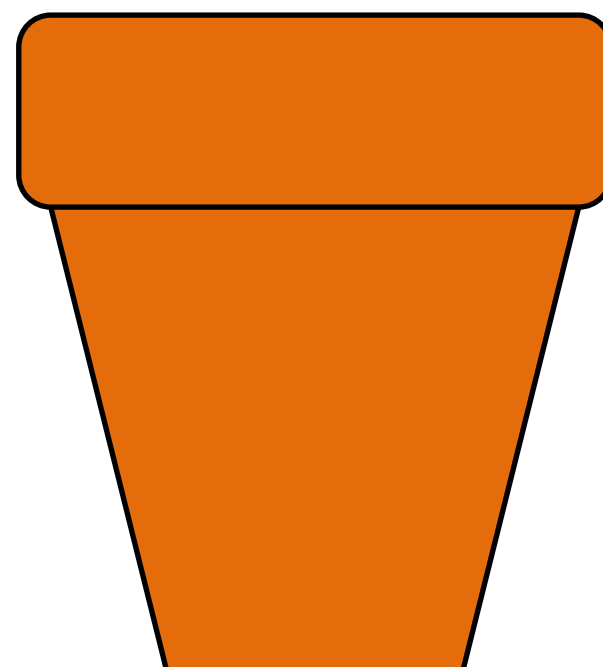
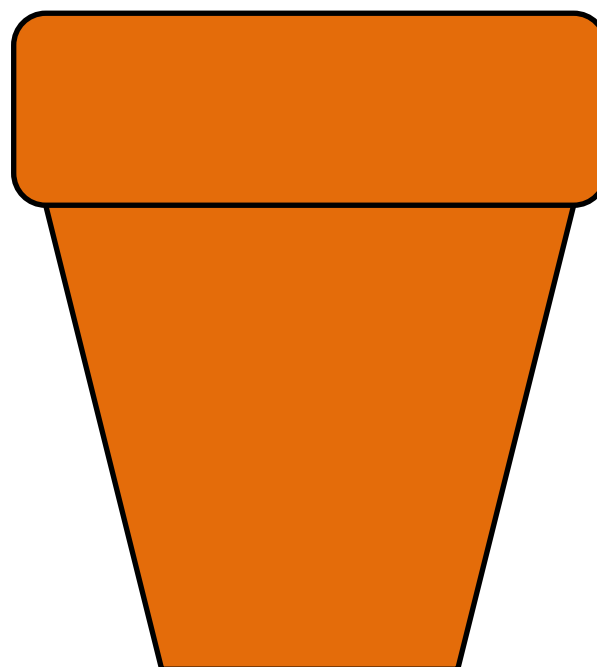
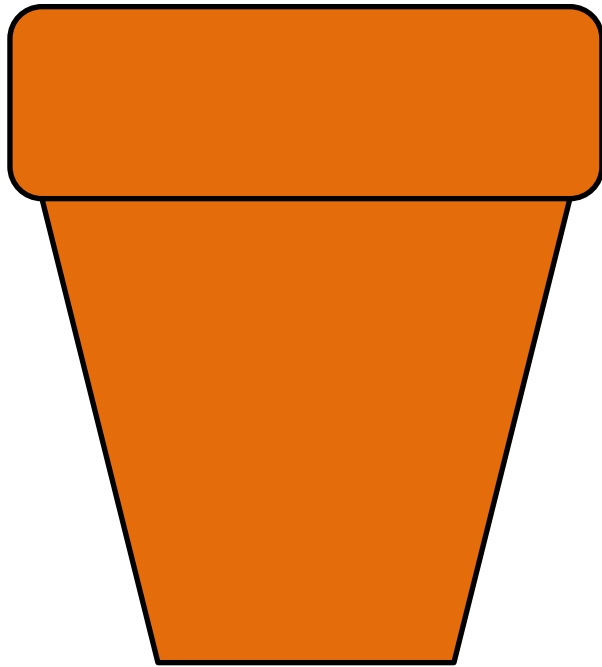

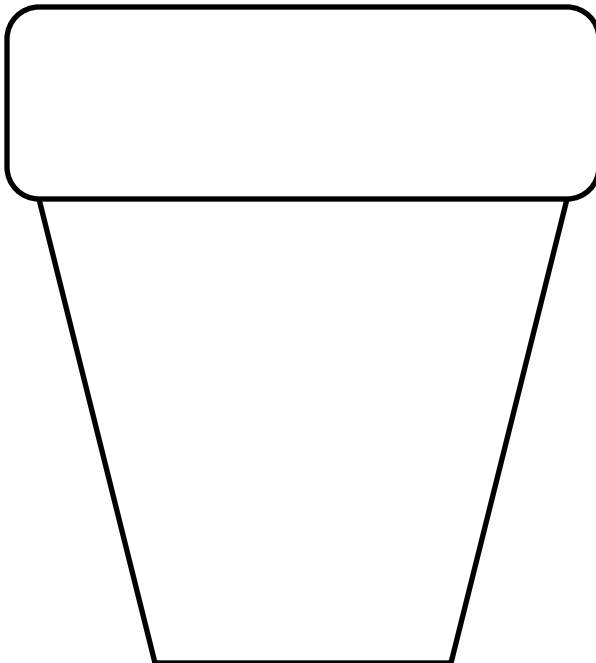
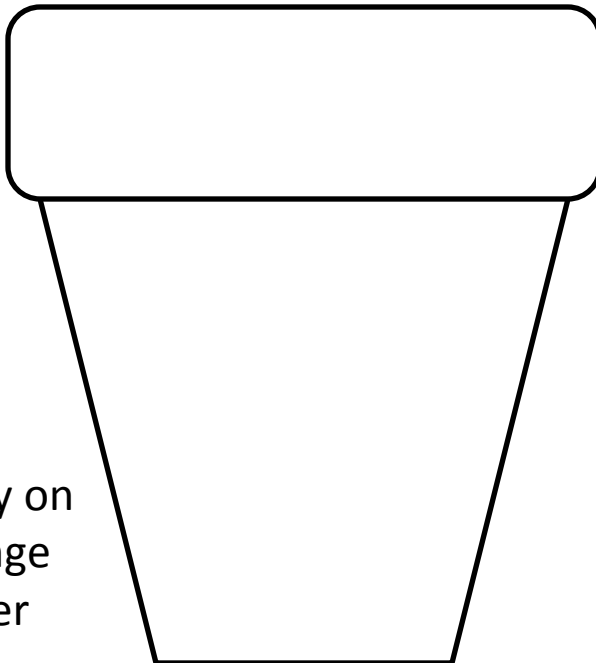
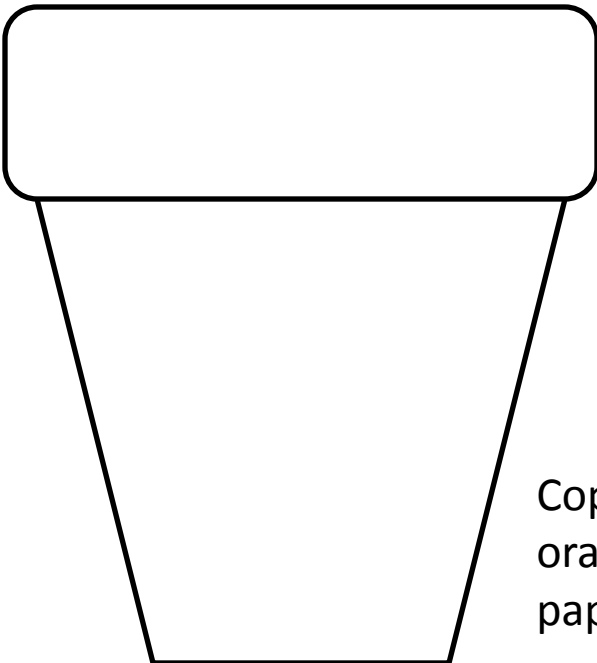

Copy on
orange
paper

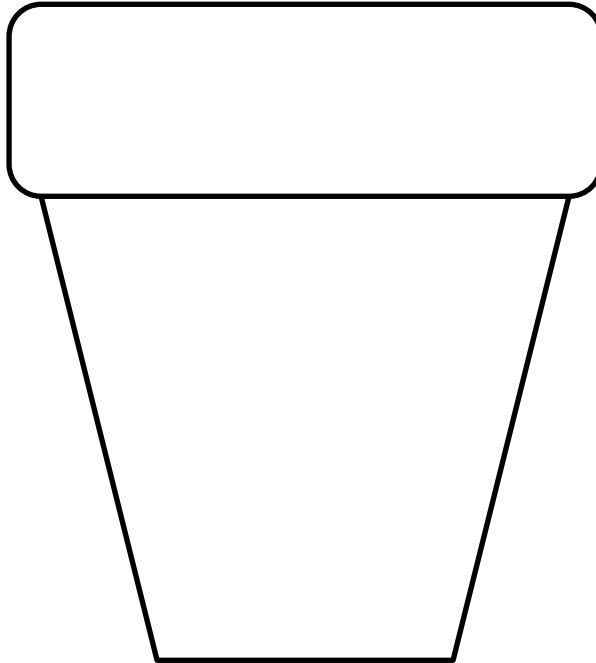
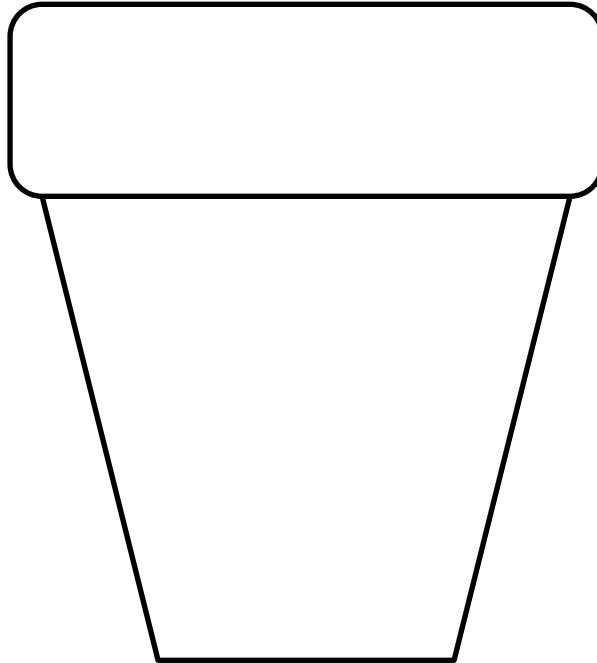
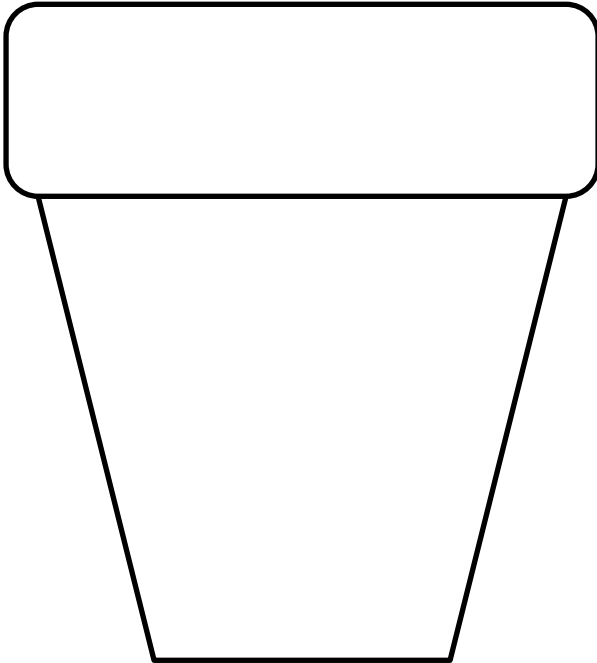

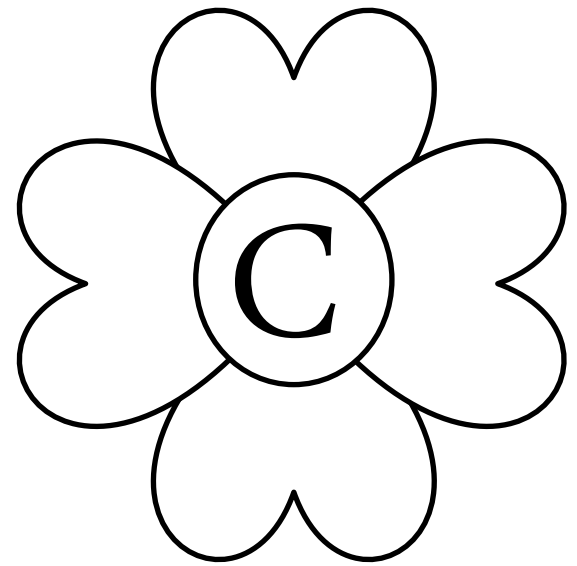
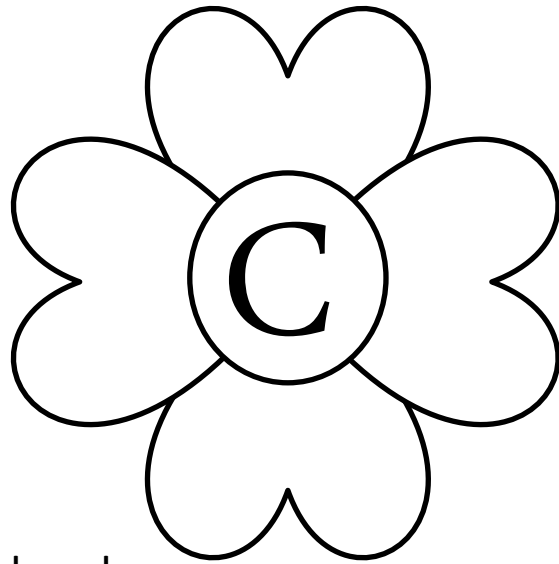
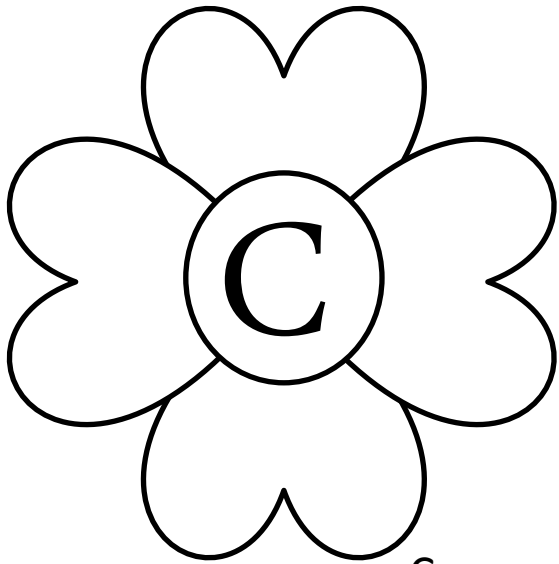

Copy on Colored
paper or
scrapbook paper
Or color your own

Set
of
6

Use
popsicle
sticks for
stem

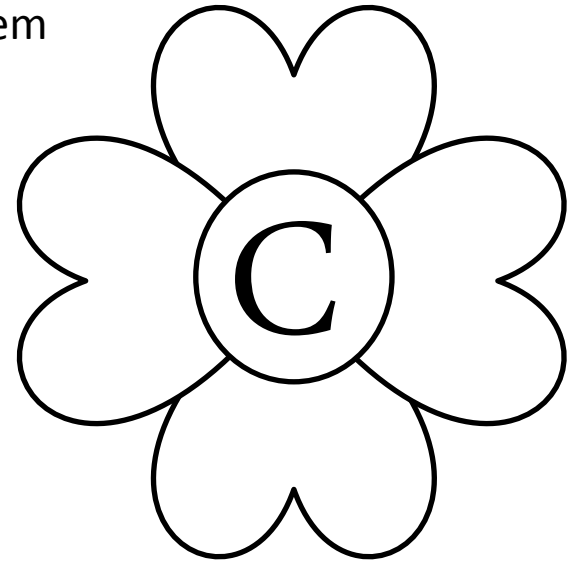
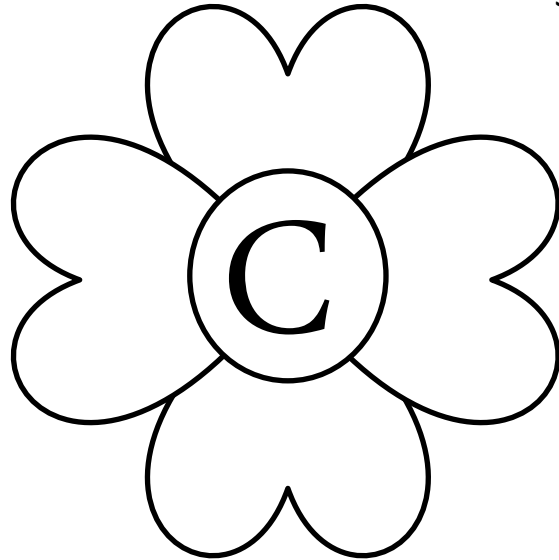
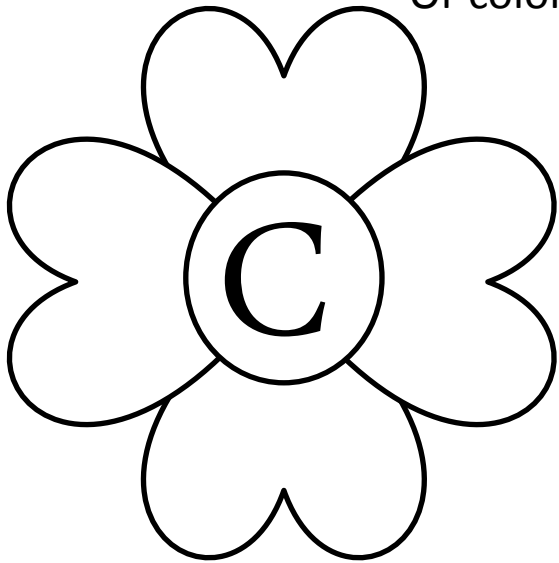

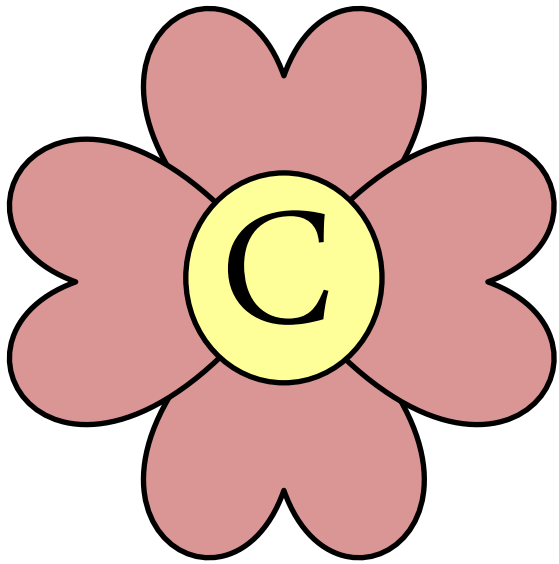

Set
of
6

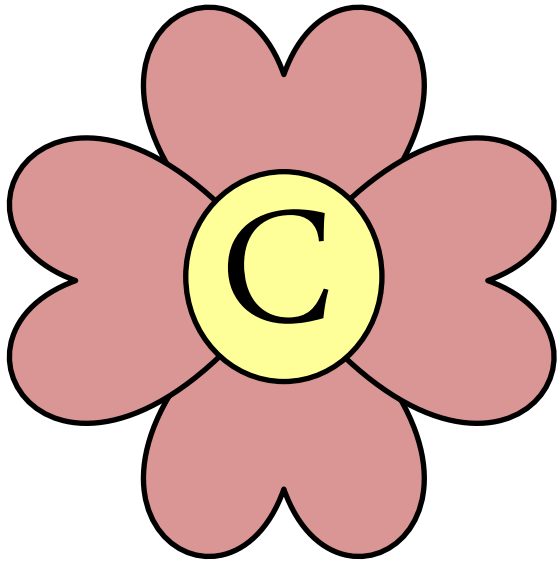
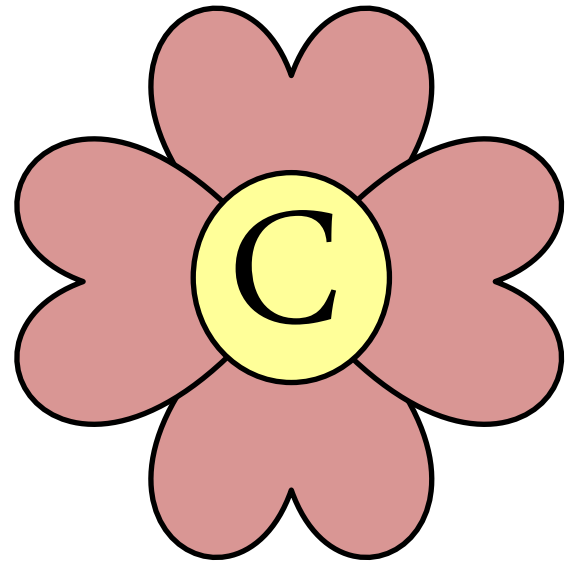
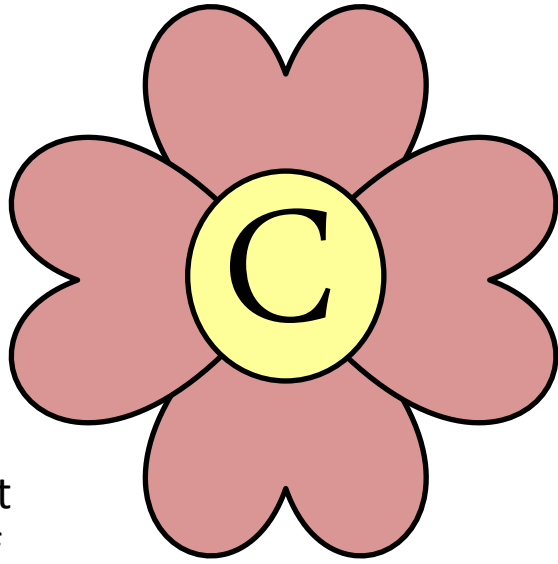

Set
of
6

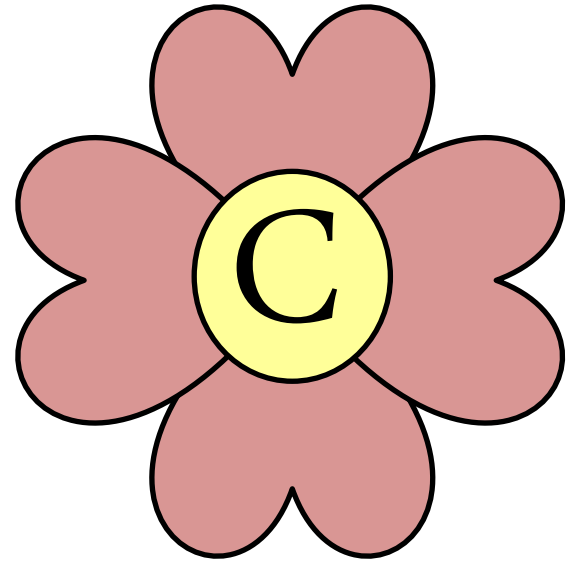
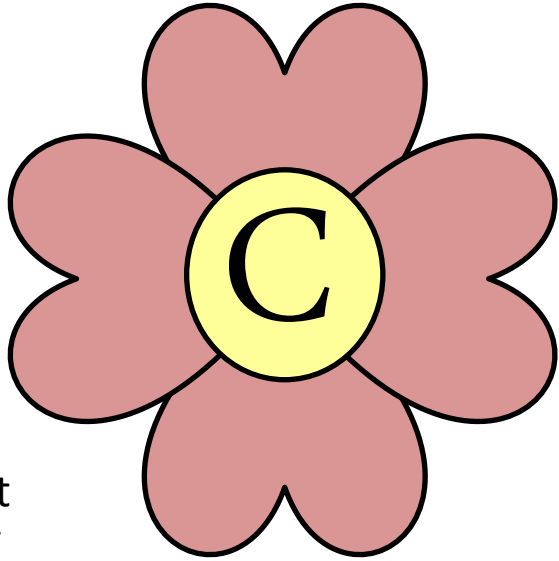

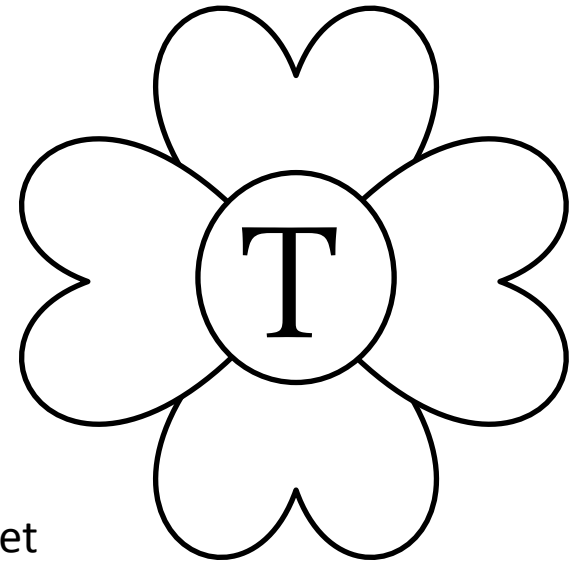
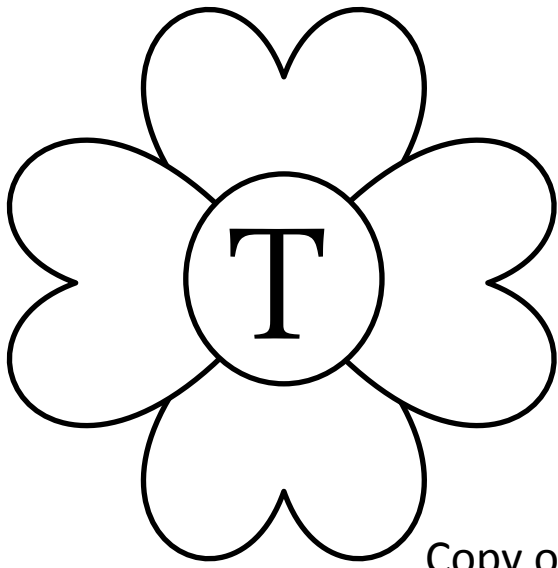

Copy on Colored
paper or
scrapbook paper
Or color your own

Set
of
6

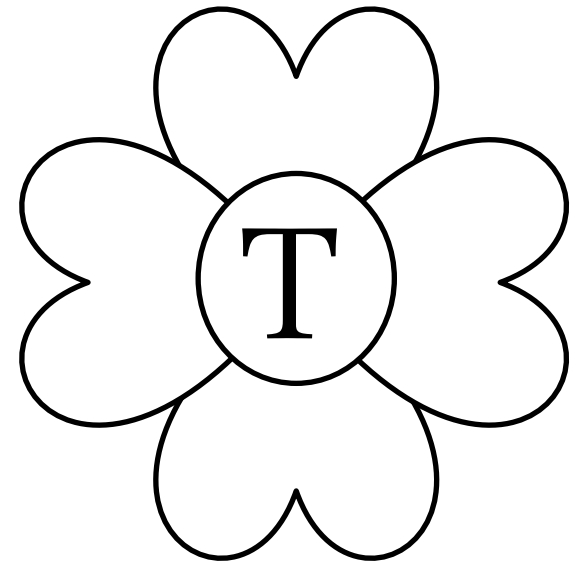
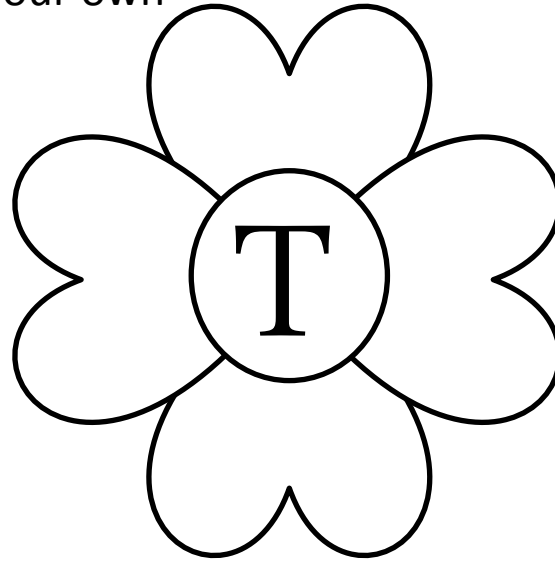
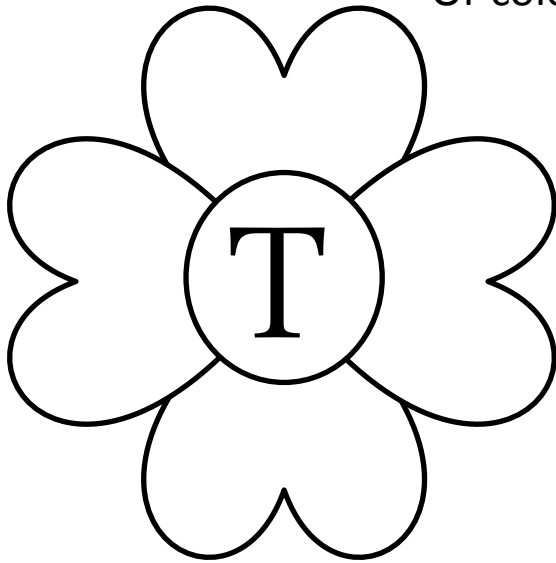

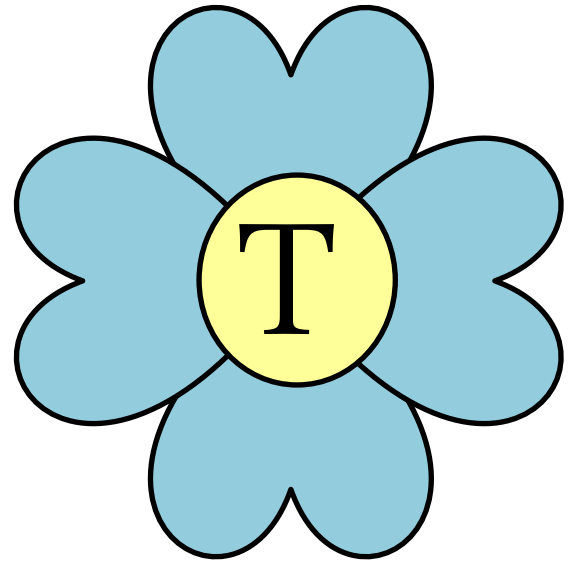
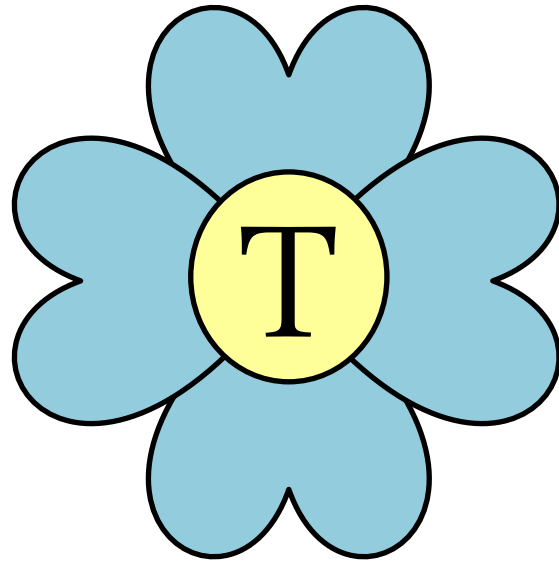
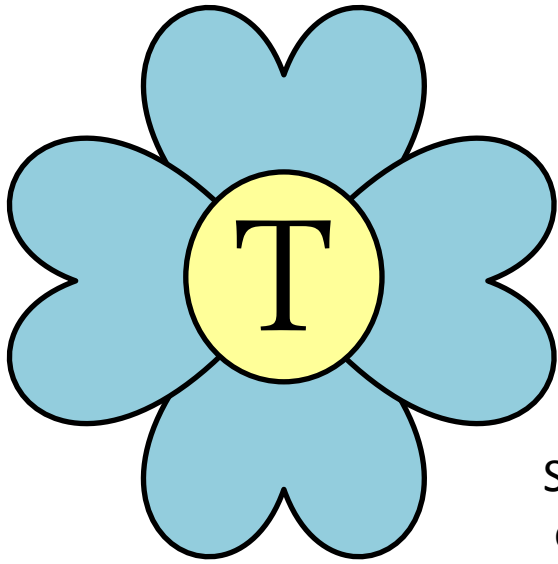

Set
of
6

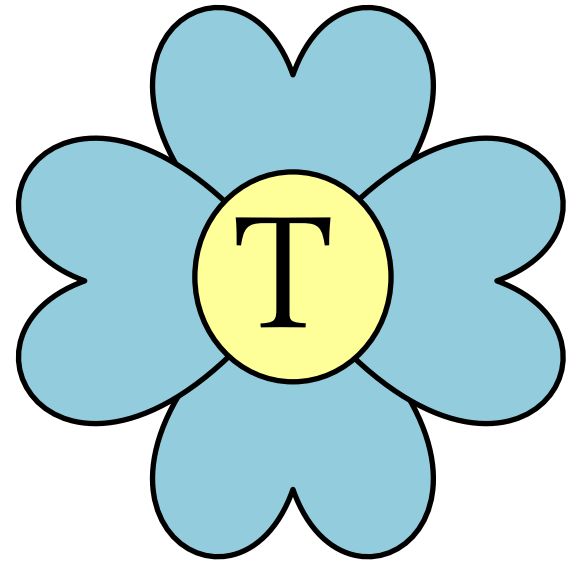
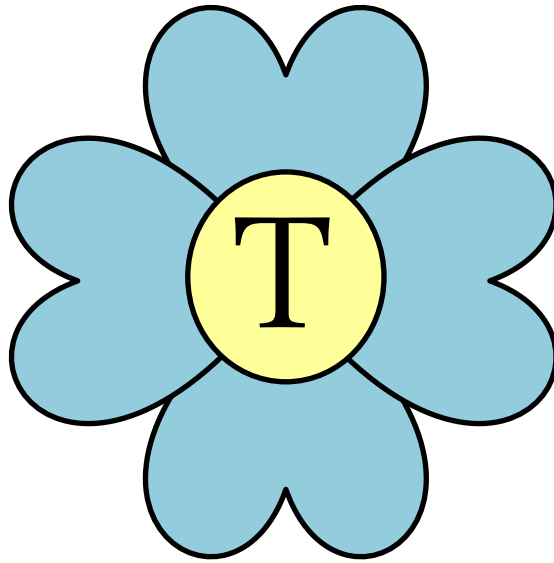
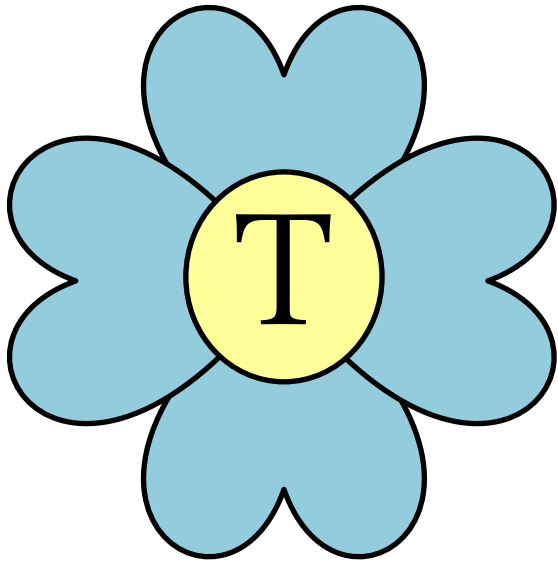

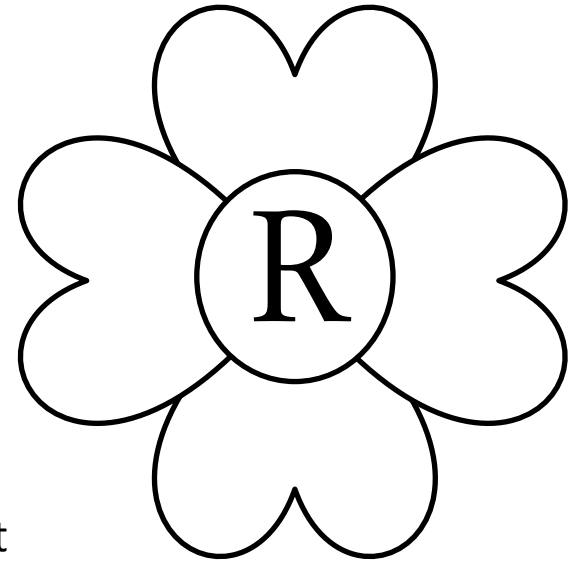
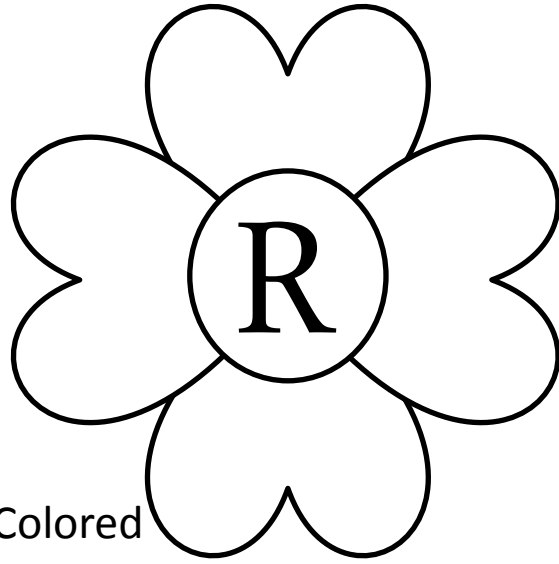
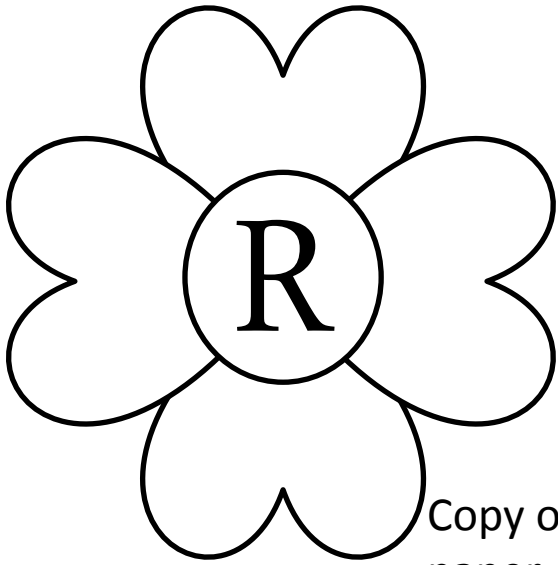

Copy on Colored
paper or
scrapbook paper
Or color your own

Set
of
6

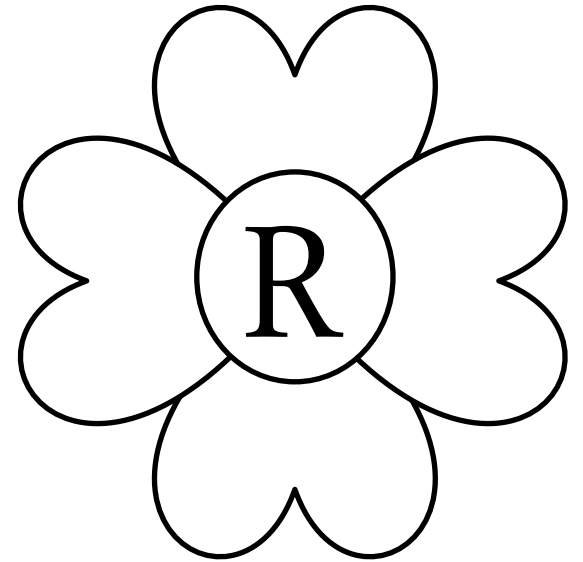
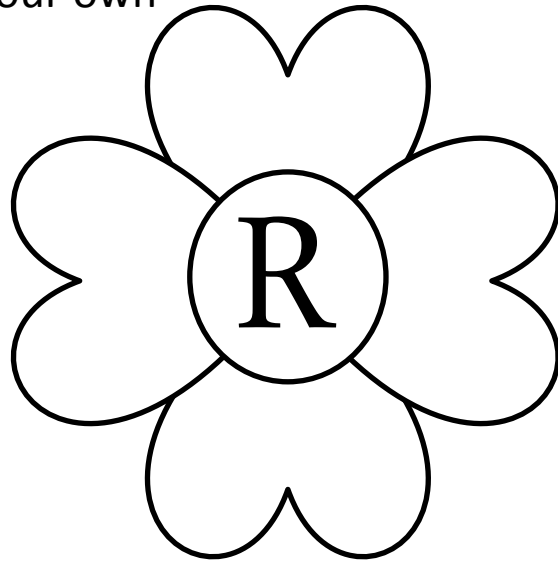
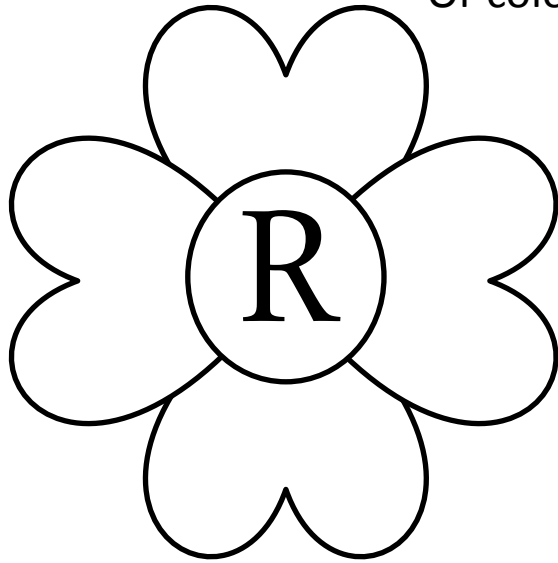

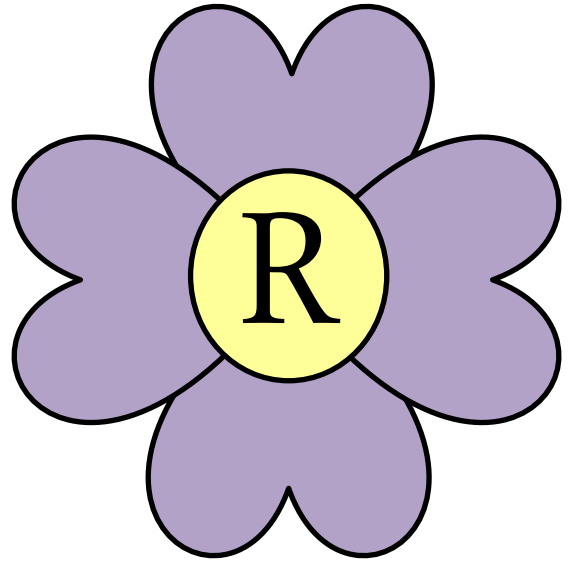
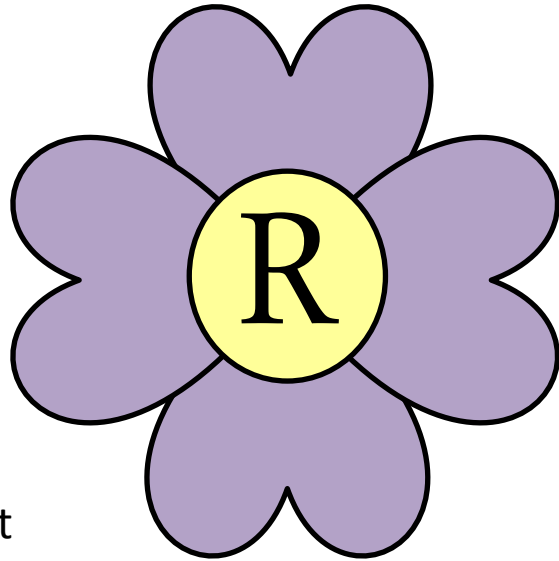
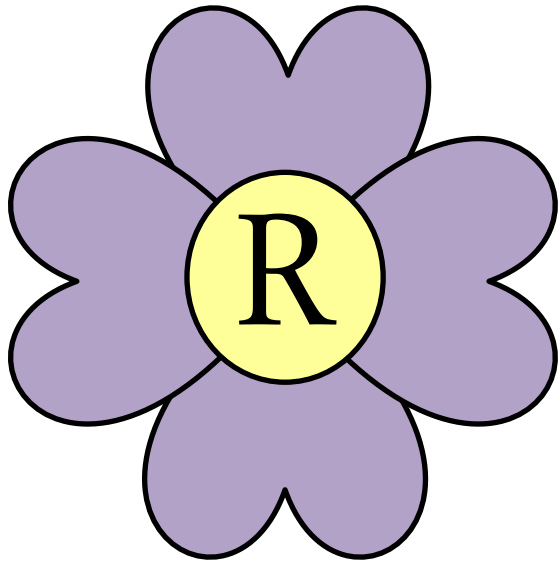

Set
of
6

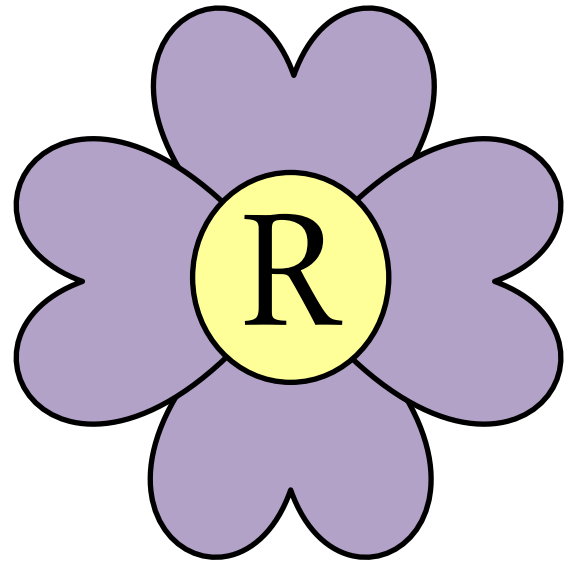
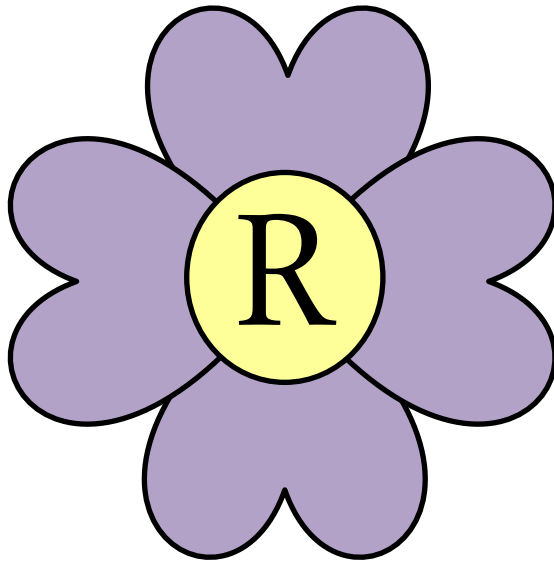
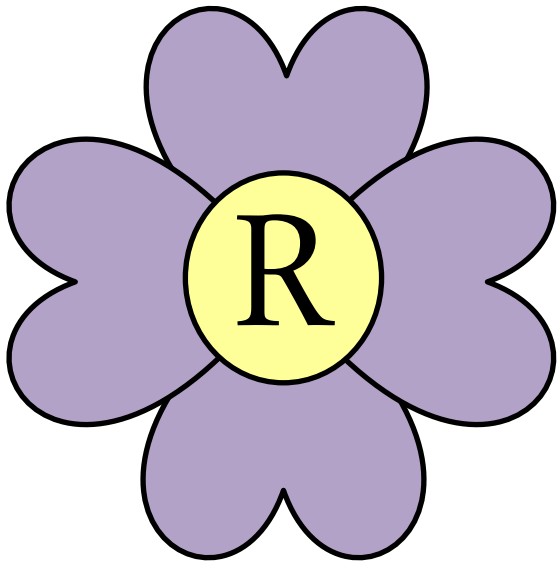

Instructions:

Copy and cut desired flowers.

Paste popsicle stick on construction paper.

Paste pot on top of popsicle stick.

Paste flower on top of popsicle stick.