

The Wandering Nephites 200 B.C. to 121 B.C.

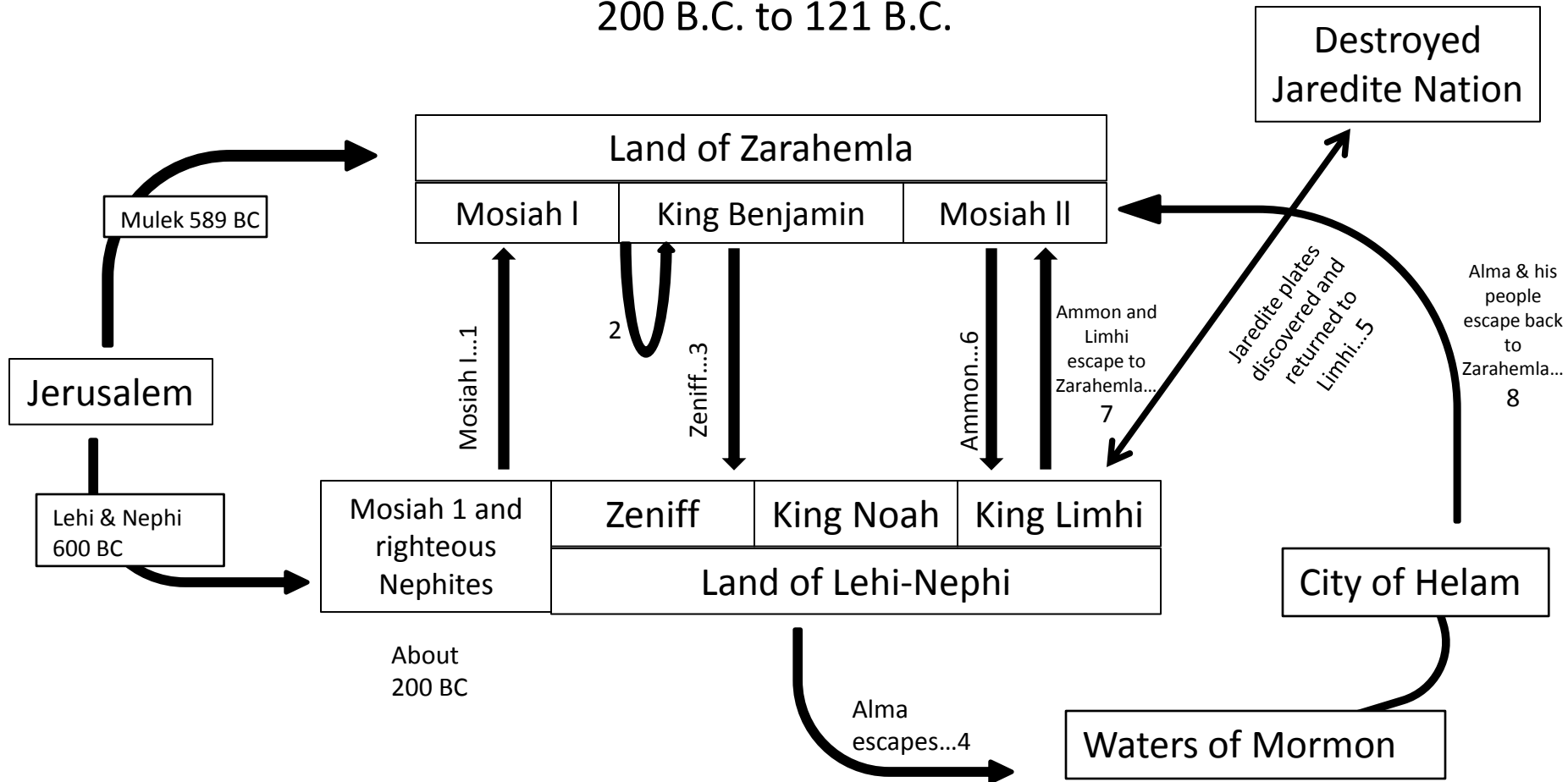

1. Mosiah I leads the few remaining righteous Nephites from the original land settled by Lehi to the Land of Zarahemla (Omni 1:3)
2. (About 200 BC ill fated expedition to return to Lehi-Nephi. Contention and infighting. All slain in the wilderness except 50 who return to Zarahemla (Omni 1:28) (Mosiah 9:1-3)
3. Zeniff leads a second expedition (abt. 200 BC) to Lehi-Nephi and settles there with the permission of King Laman (Mosiah 9: 3-10)
4. (about 148 BC) Alma flees King Noah to the Waters of Mormon (Mosiah 17 and 18)
5. (about 121 BC) King Limhi sends expedition of 43 men to find Zarahemla in hopes of escaping Lamanite bondage. They find remnants of Jaredites and 24 gold plates and return to Land of Lehi-Nephi (Mosiah 6: 7-8)
6. (About 121 BC) Ammon's expedition (16 "Strong Men") to find Zeniff's colony (Mosiah 7)
7. (About 121-120 BC) King Limhi's people get the Lamanites drunk and escape back to Zarahemla (Mosiah 22)
8. (Between 145 and 121 BC) Alma and his people escape Lamanites and return to Zarahemla (Mosiah 24)

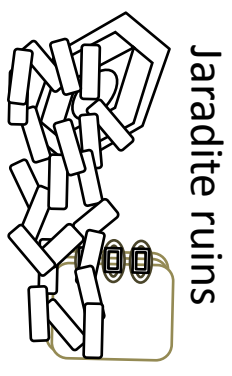

Jaradite ruins

Land of Zarahemla

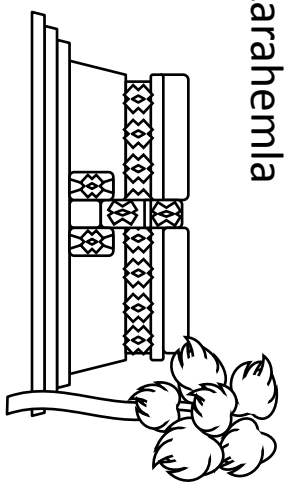

Land of Helam

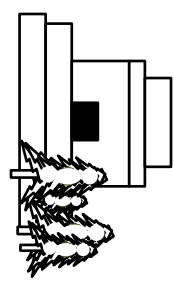

Waters of Mormon



Land of Nephi

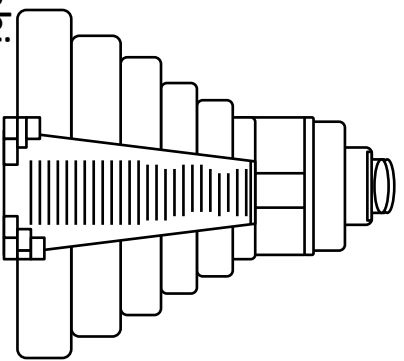

Land of Zarahemla

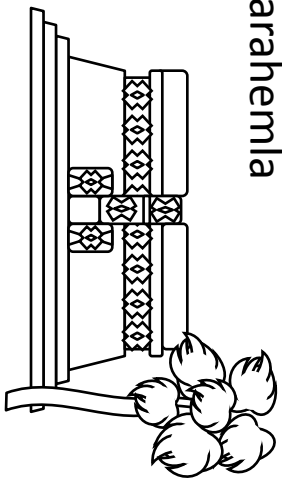

Jaradite ruins

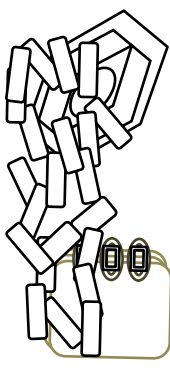

Waters of Mormon



Land of Nephi

