

Proxy:
The person doing the
work or activity

Primary 5 D&C and
Church History:
Lesson 34 Joseph
Smith Teaches
about Baptism for
the Dead

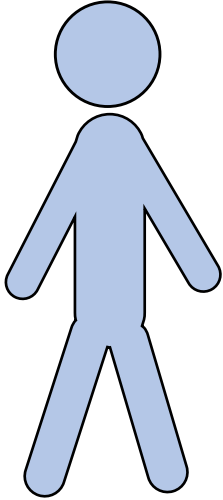

In the temple we can be baptized for
people who died without being
baptized.

Baptisms can be done only by people
living on the earth, it is an earthly
ordinance.

Baptisms for the dead were preformed
after Jesus' resurrection

Thus was the gospel preached to those who
had died in their sins, without
a knowledge of the truth, or in transgression,
having rejected the prophets.

These were taught faith in God, repentance
from sin, vicarious baptism for
the remission of sins, the gift of the Holy
Ghost by the laying on of hands,..
D&C 138:32-33



Vicarious:
A person does something
in place of someone else.

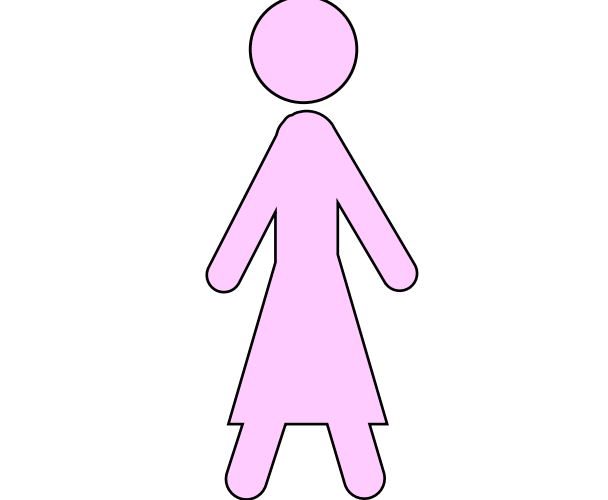

We are the ones who go
down into the water and are
baptized, but they are the
ones for whom the baptism
counts.

While we are on the earth,
we can help people who
have not been baptized by
doing vicarious baptisms for
them..

Proxy:
The person doing the
work or activity

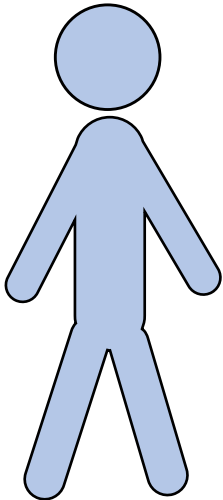

In the temple we can be baptized for
people who died without being
baptized.

Baptisms can be done only by people
living on the earth, it is an earthly
ordinance.

Baptisms for the dead were preformed
after Jesus' resurrection

Thus was the gospel preached to those who
had died in their sins, without
a knowledge of the truth, or in transgression,
having rejected the prophets.

These were taught faith in God, repentance
from sin, vicarious baptism for
the remission of sins, the gift of the Holy
Ghost by the laying on of hands,..
D&C 138:32-33

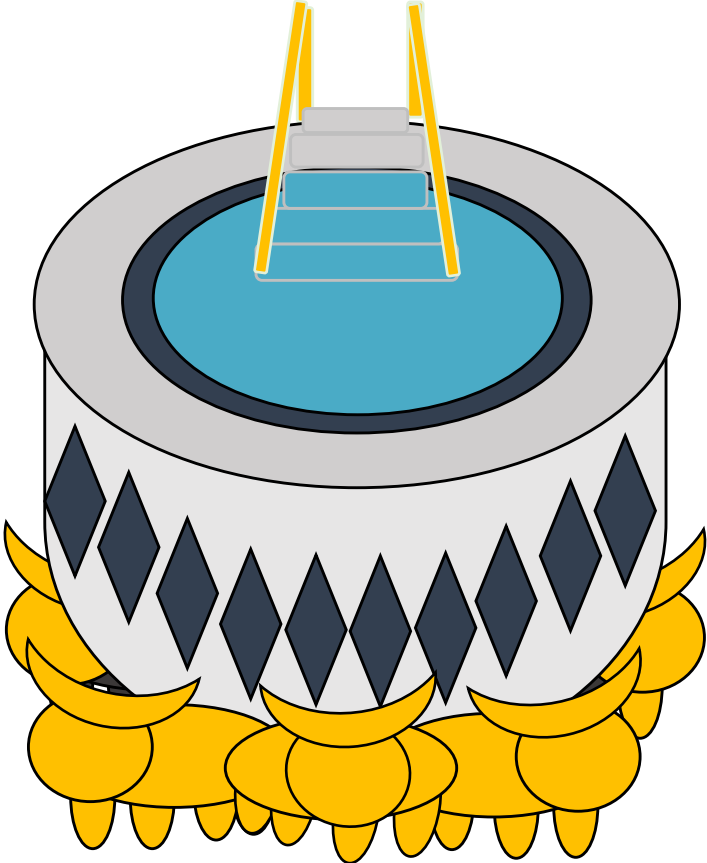

Vicarious:
A person does something
in place of someone else.

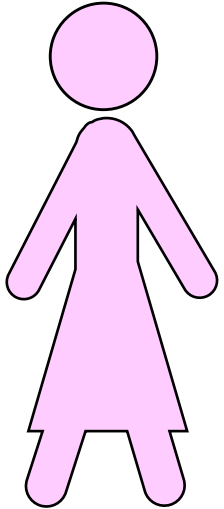

We are the ones who go
down into the water and are
baptized, but they are the
ones for whom the baptism
counts.

While we are on the earth,
we can help people who
have not been baptized by
doing vicarious baptisms for
them..

Proxy:

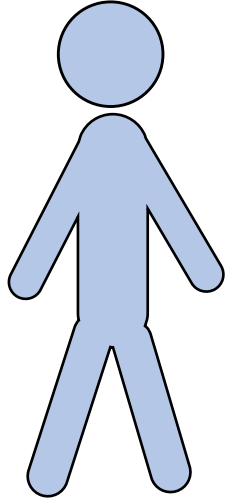

Three empty rectangular boxes stacked vertically, intended for notes or descriptions related to the proxy.

Thus was the gospel preached to those who had died in their sins, without a knowledge of the truth, or in transgression, having rejected the prophets.

These were taught faith in God, repentance from sin, vicarious baptism for the remission of sins, the gift of the Holy Ghost by the laying on of hands,..
D&C 138:32-33



Vicarious:

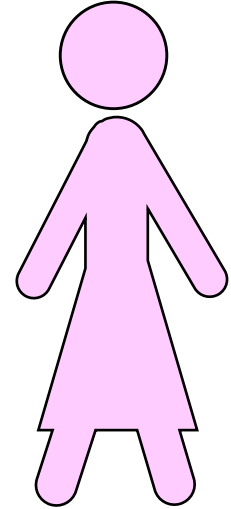

Two empty rectangular boxes stacked vertically, intended for notes or descriptions related to the vicarious proxy.

Proxy:

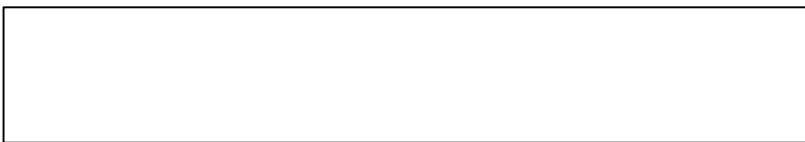
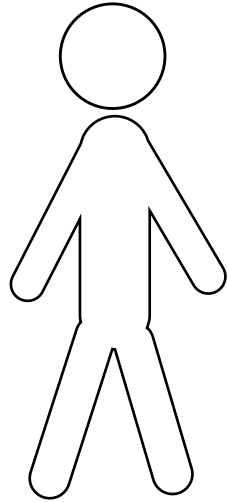

Thus was the gospel preached to those who had died in their sins, without a knowledge of the truth, or in transgression, having rejected the prophets.

These were taught faith in God, repentance from sin, vicarious baptism for the remission of sins, the gift of the Holy Ghost by the laying on of hands,..
D&C 138:32-33

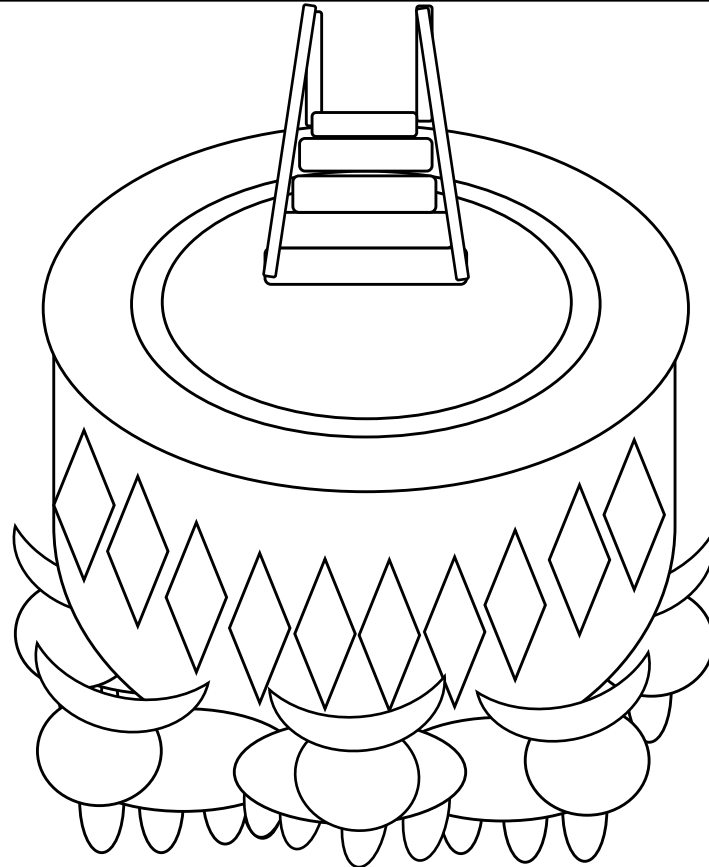

Vicarious:

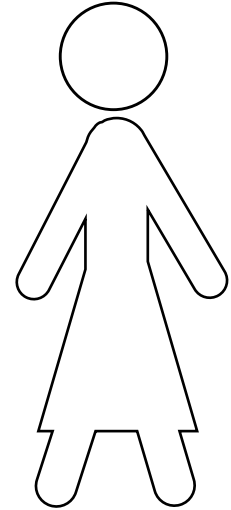

Proxy:
The person doing the work or activity

SET OF 3

In the temple we can be baptized for people who died without being baptized.

Baptisms can be done only by people living on the earth, it is an earthly ordinance.

Baptisms for the dead were preformed after Jesus' resurrection

Vicarious:
A person does something in place of someone else.

We are the ones who go down into the water and are baptized, but they are the ones for whom the baptism counts.

While we are on the earth, we can help people who have not been baptized by doing vicarious baptisms for them..

Proxy:
The person doing the work or activity

In the temple we can be baptized for people who died without being baptized.

Baptisms can be done only by people living on the earth, it is an earthly ordinance.

Baptisms for the dead were preformed after Jesus' resurrection

Vicarious:
A person does something in place of someone else.

We are the ones who go down into the water and are baptized, but they are the ones for whom the baptism counts.

While we are on the earth, we can help people who have not been baptized by doing vicarious baptisms for them..

Proxy:
The person doing the work or activity

In the temple we can be baptized for people who died without being baptized.

Baptisms can be done only by people living on the earth, it is an earthly ordinance.

Baptisms for the dead were preformed after Jesus' resurrection

Vicarious:
A person does something in place of someone else.

We are the ones who go down into the water and are baptized, but they are the ones for whom the baptism counts.

While we are on the earth, we can help people who have not been baptized by doing vicarious baptisms for them..

Proxy:

The person doing the work or activity

Baptisms can be done only by people living on the earth, it is an earthly ordinance.

Vicarious:

A person does something in place of someone else.

In the temple we can be baptized for people who died without being baptized.

Baptisms for
the dead were
performed after
Jesus'
resurrection

We are the ones who go down
into the water and are
baptized, but they are the ones
for whom the baptism counts.

While we are on the earth, we can
help people who have not been
baptized by doing vicarious
baptisms for them..

Cut and paste activity:

Page 2: Handout only

Page 3: copy and cut page 5 words and paste on page 3 or 4

Page 4: Black and white. Color then copy words and paste

Page 6-7: You could also have the children write the statements in the squares by copying the large statements and putting on the board instead of cutting and pasting.