

James 2:14
What doth it profit, my
brethren, though a man say
he hath faith, and have not
works? can faith save him?

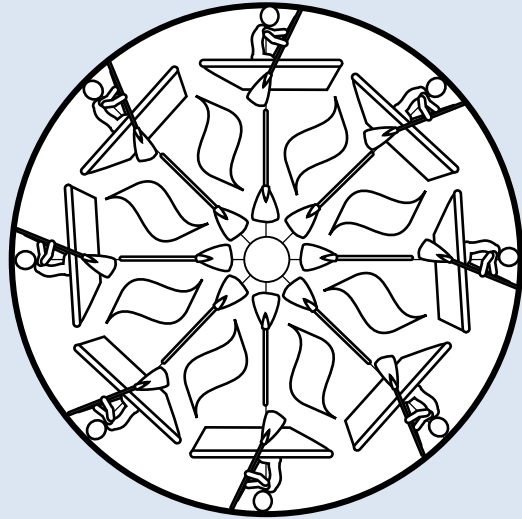

Includes circle fun
coloring page

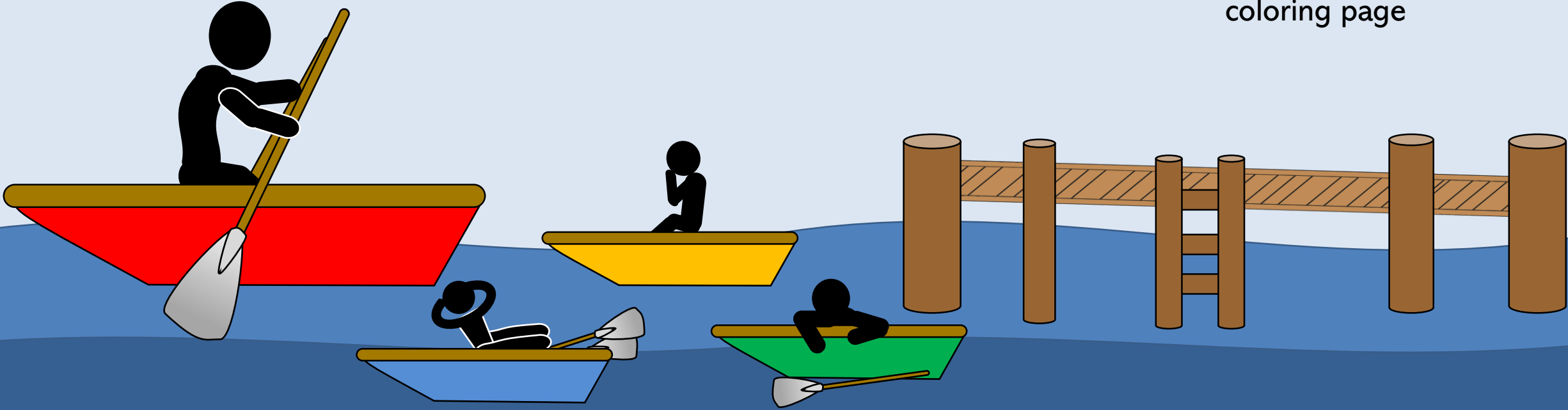

James 2:14

What doth it profit, my
brethren, though a man say
he hath faith, and have not
works? can faith save him?

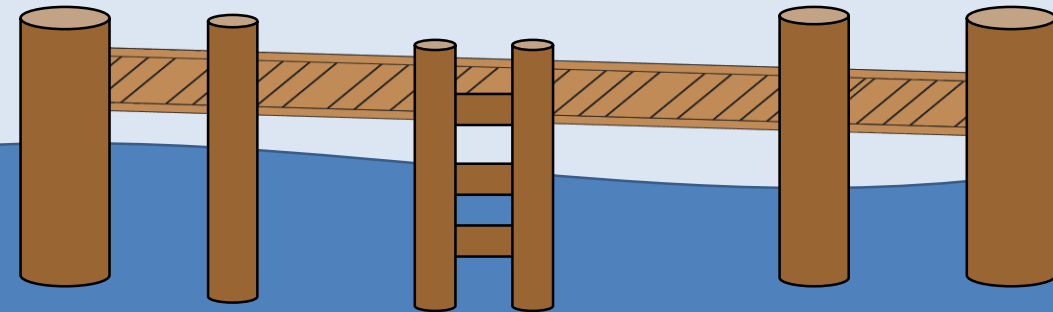

James 2:14

What doth it profit, my
brethren, though a man say
he hath faith, and have not
works? can faith save him?

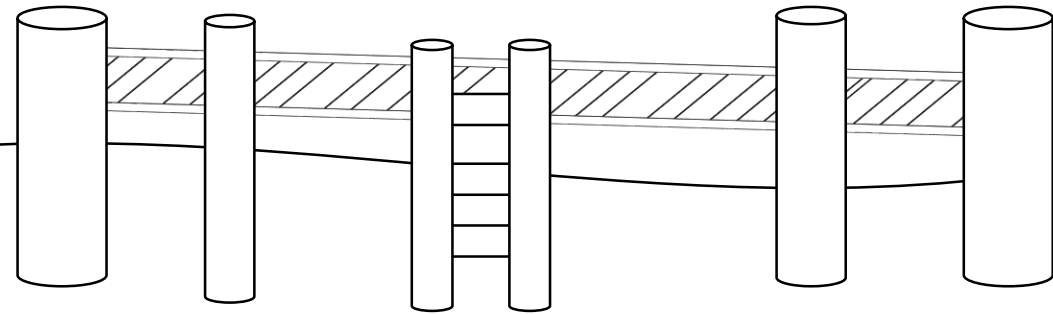

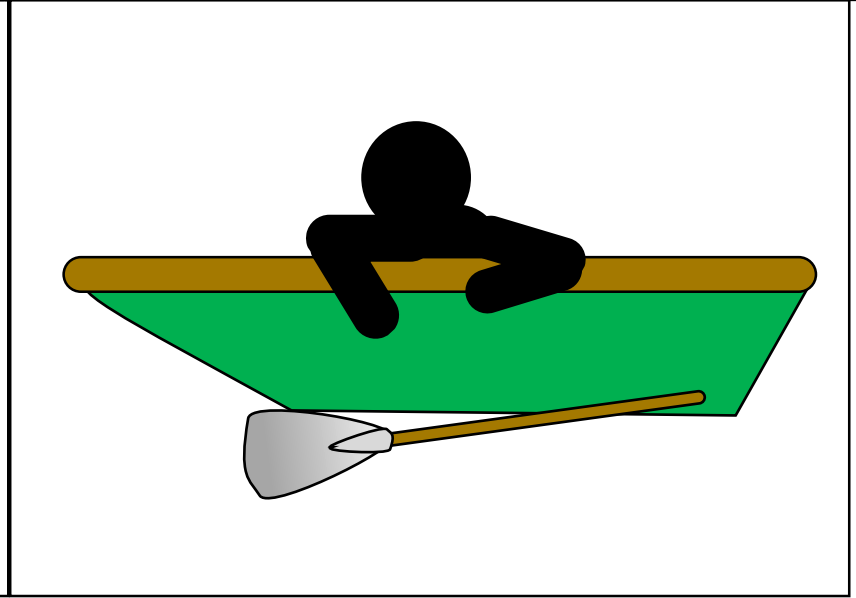
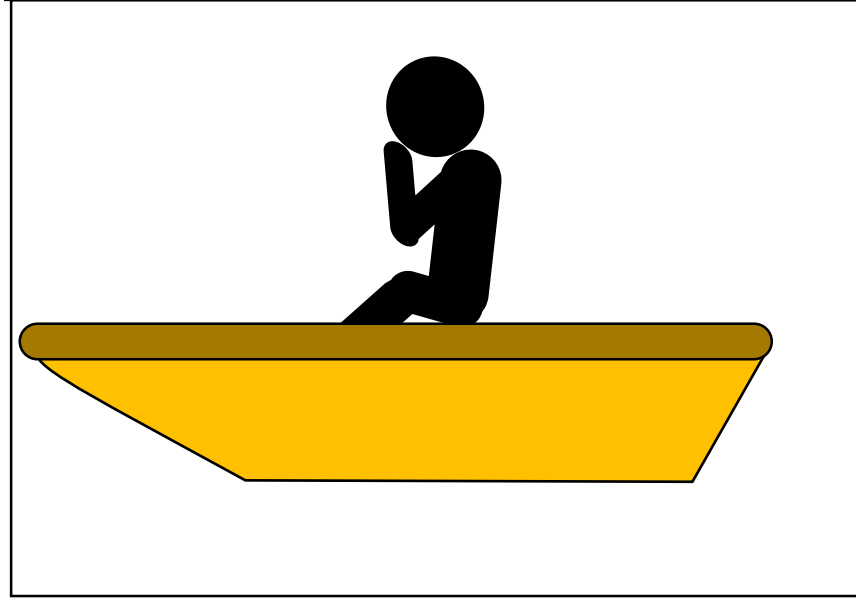
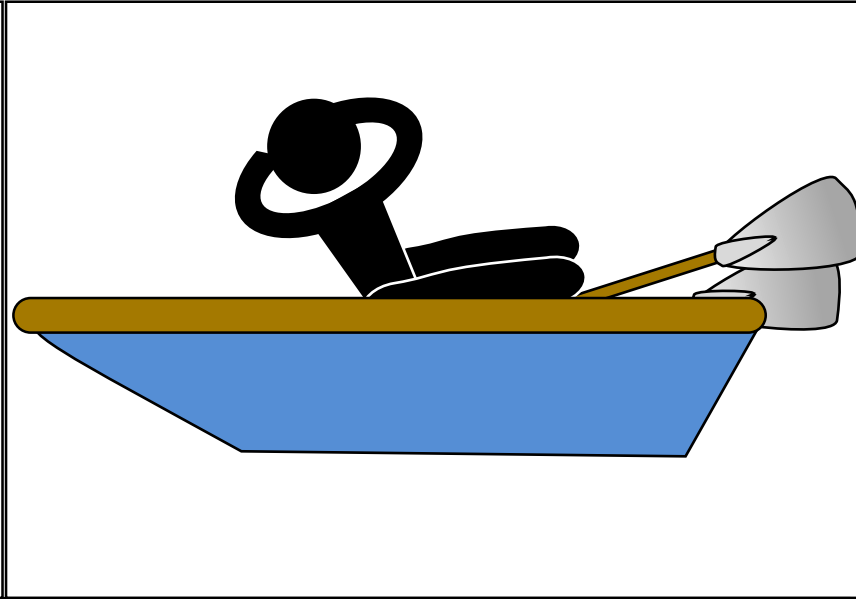
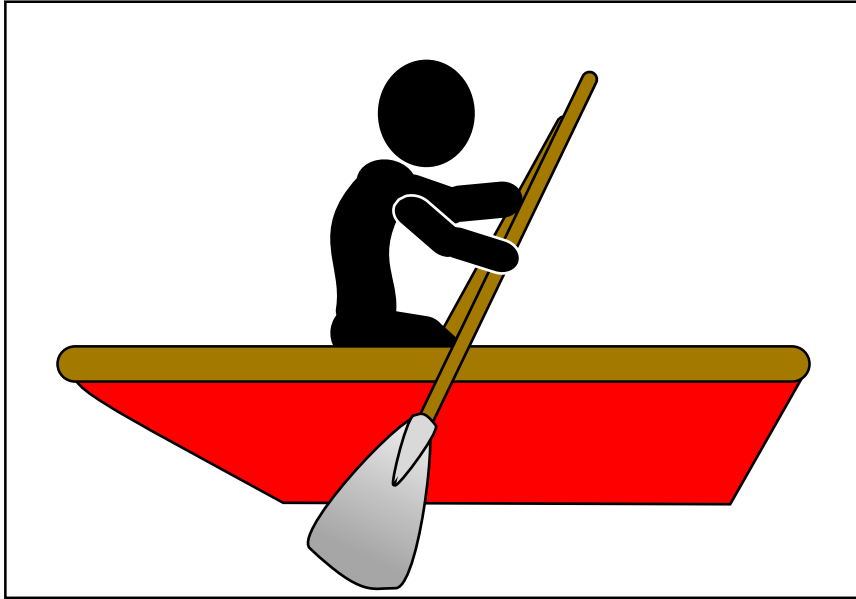

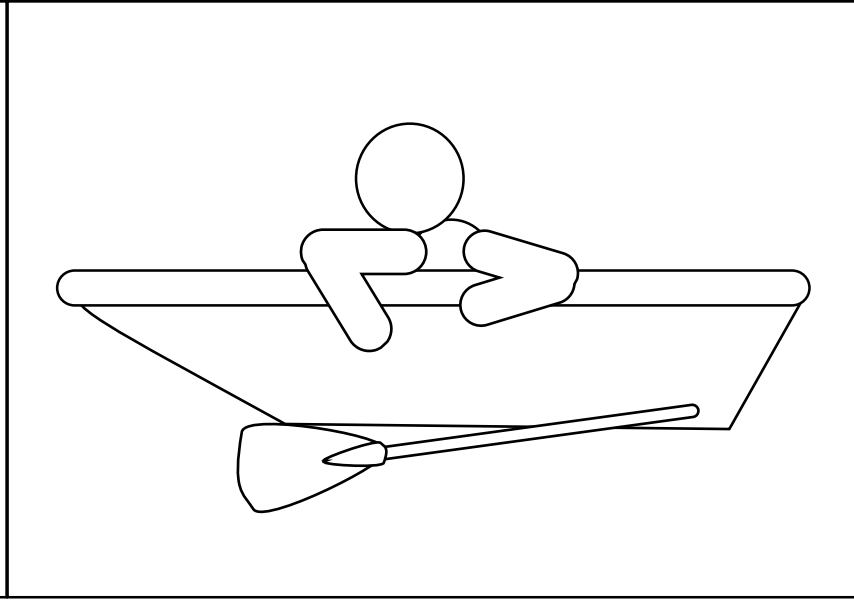
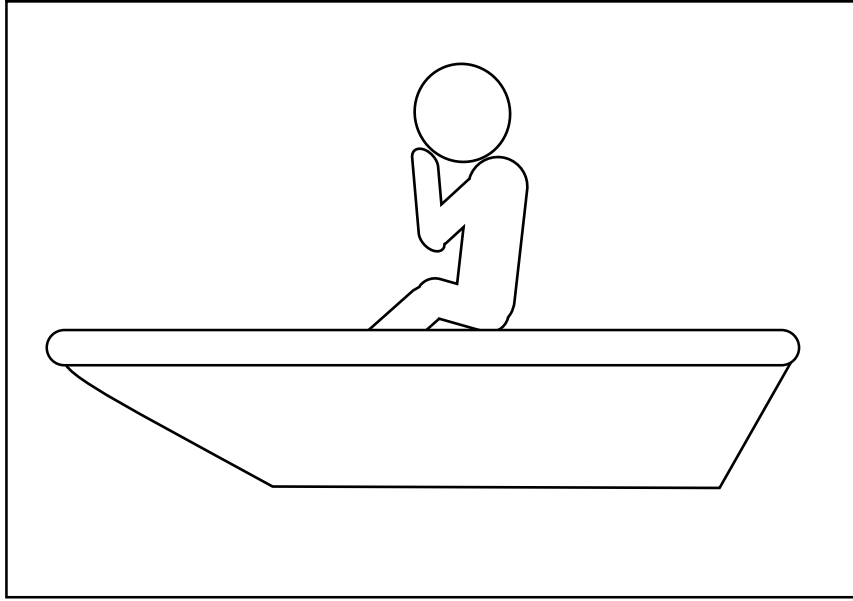
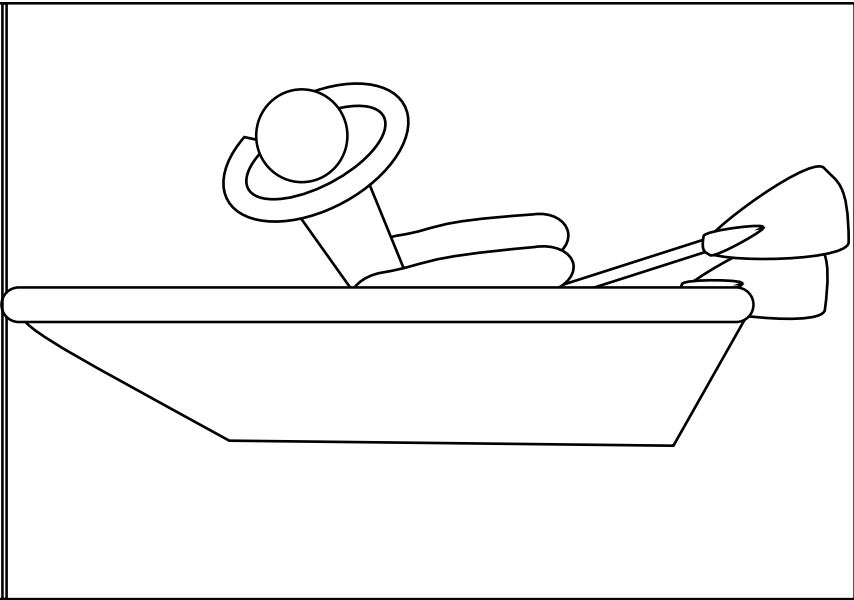
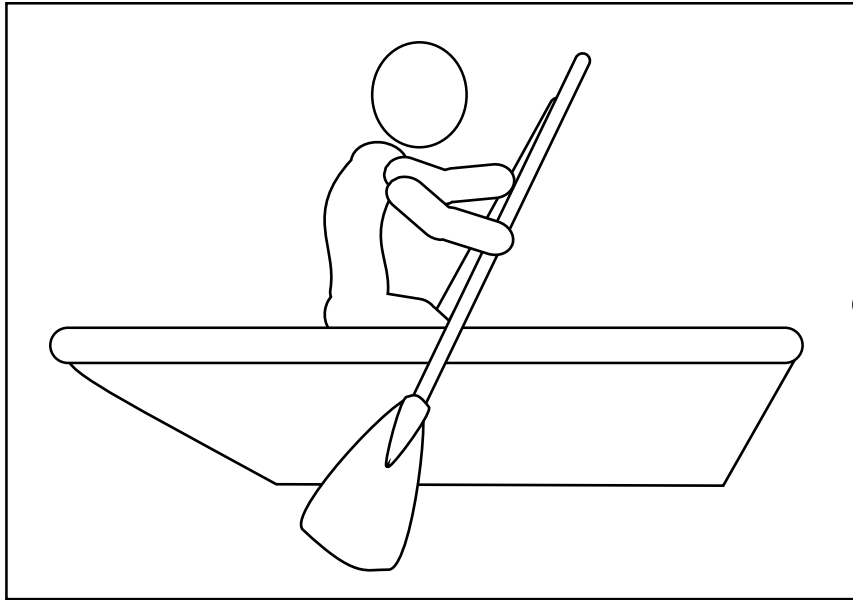

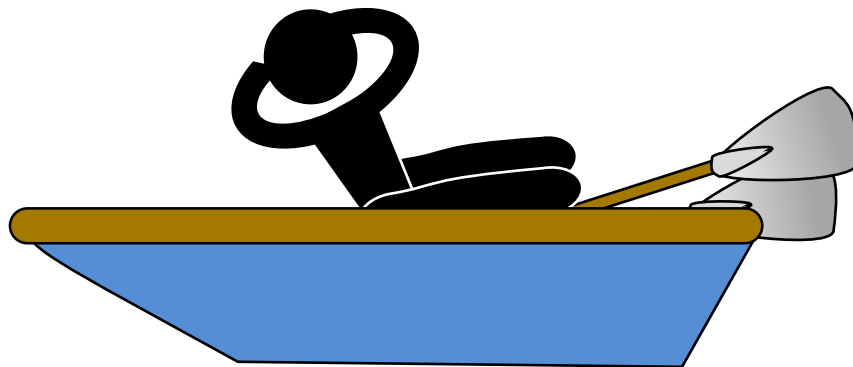

James 2:14
What doth it profit, my
brethren, though a man say
he hath faith, and have not
works? can faith save him?

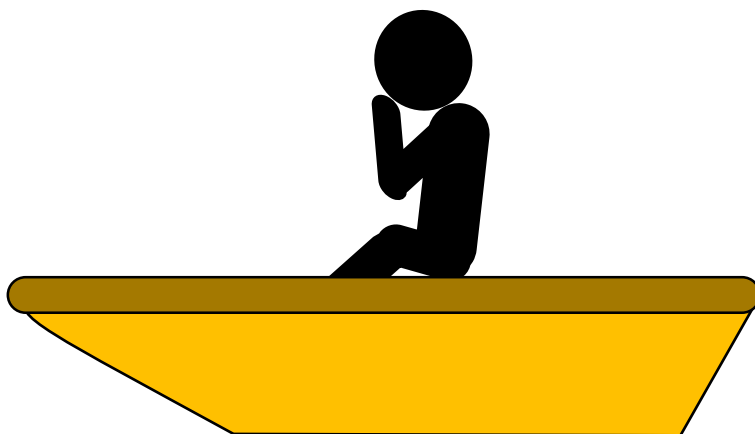
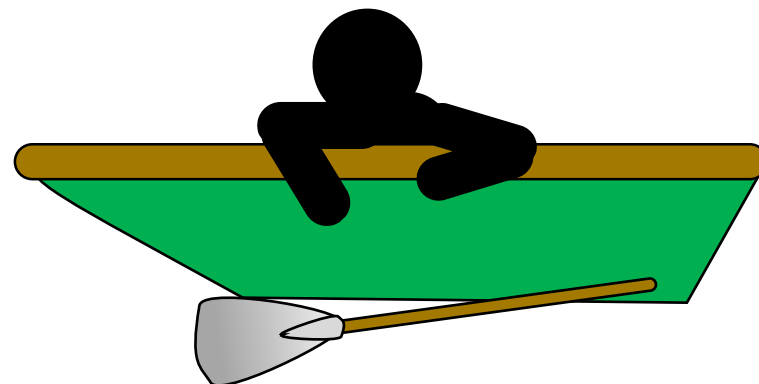

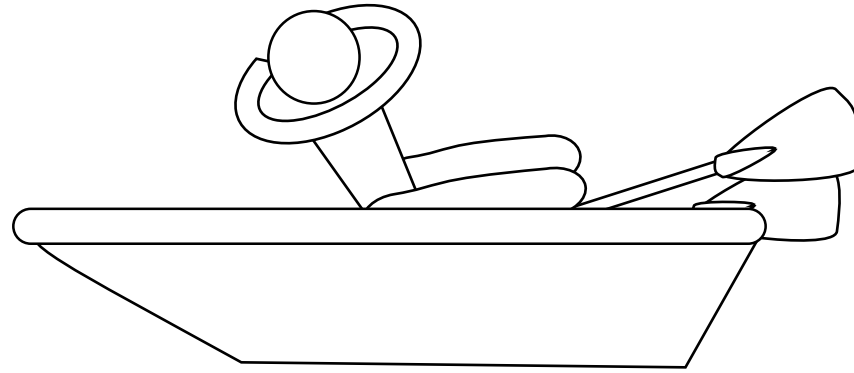
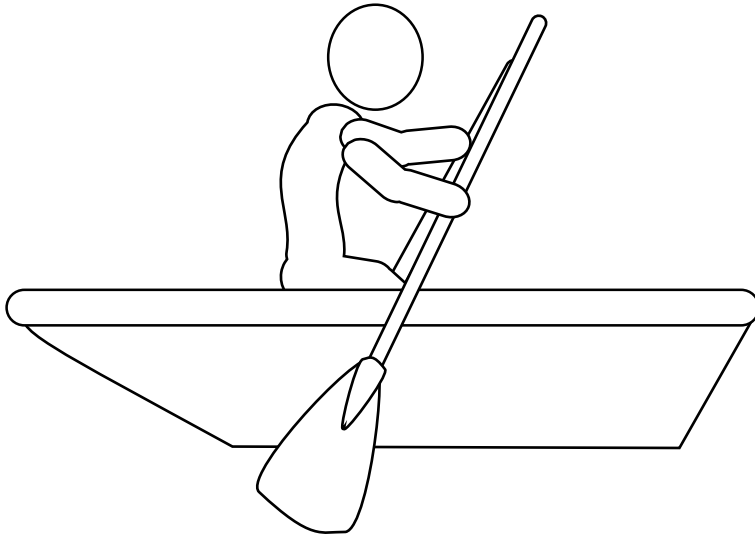

James 2:14
What doth it profit, my
brethren, though a man say
he hath faith, and have not
works? can faith save him?

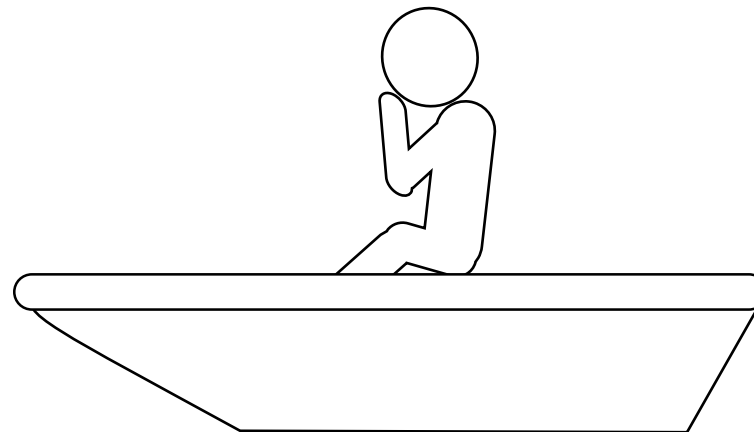
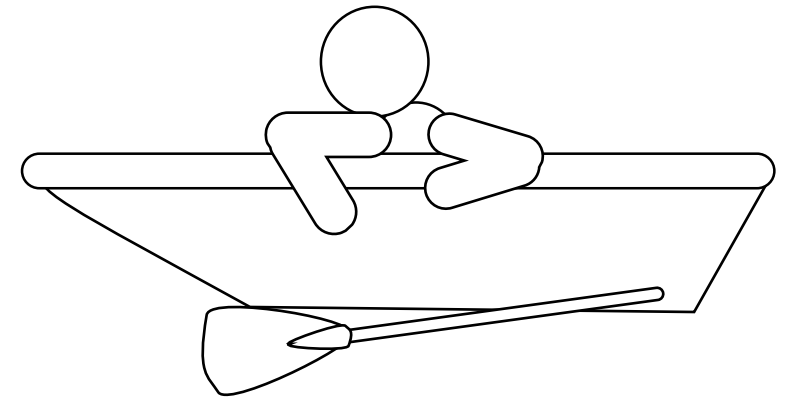

James 2:14

What doth it profit, my
brethren, though a man say
he hath faith, and have not
works? can faith save him?

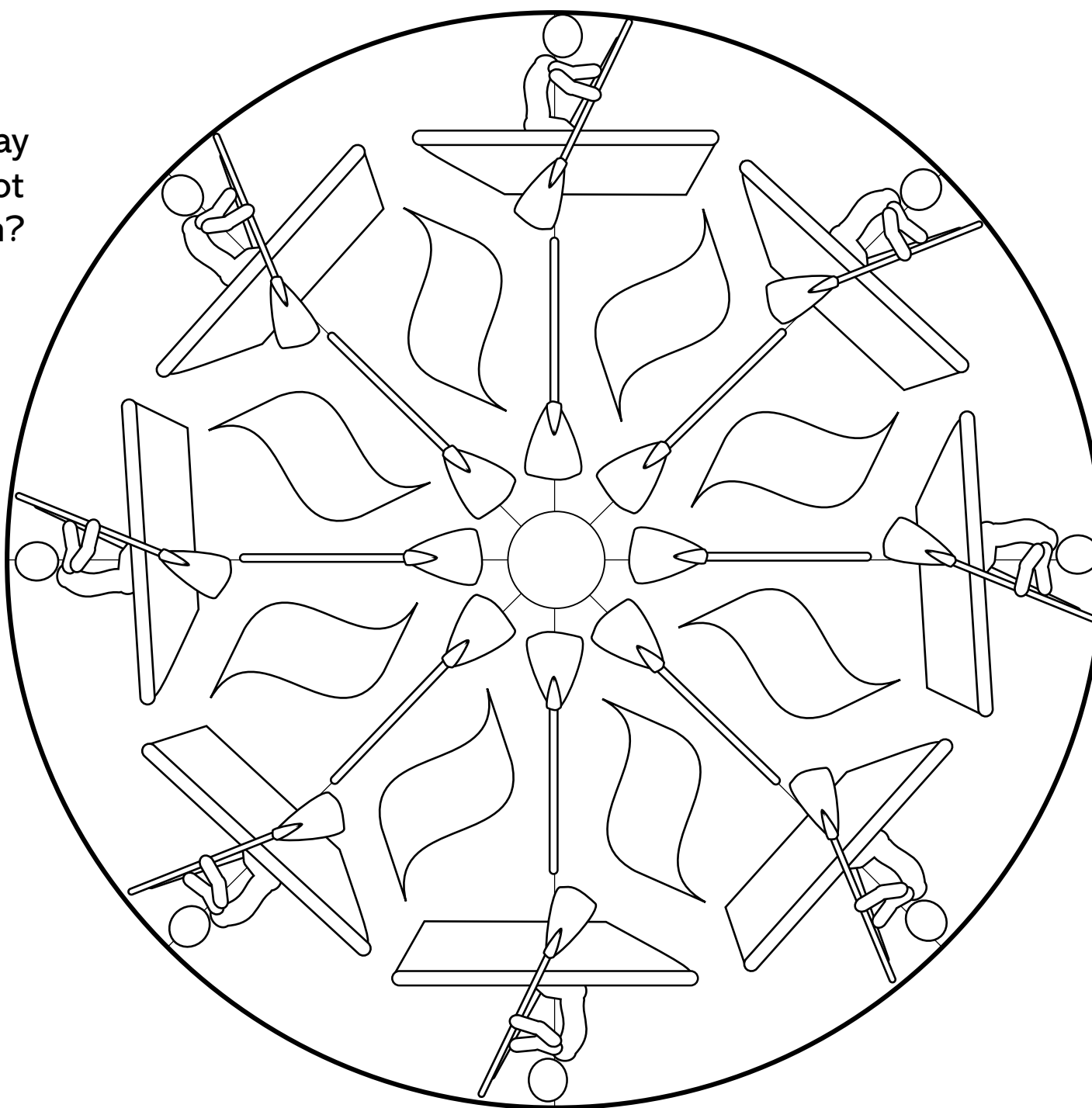

Instructions:

Cut out the man in the boat on pages 4 or 5 (who has faith) and paste it on either page 2 or 3.

Color page 3 and 5

Or use page 6 as a handout

Or use page 7 color as a handout

Page 8 Coloring Circle Fun