

**Psalms 119: 105**

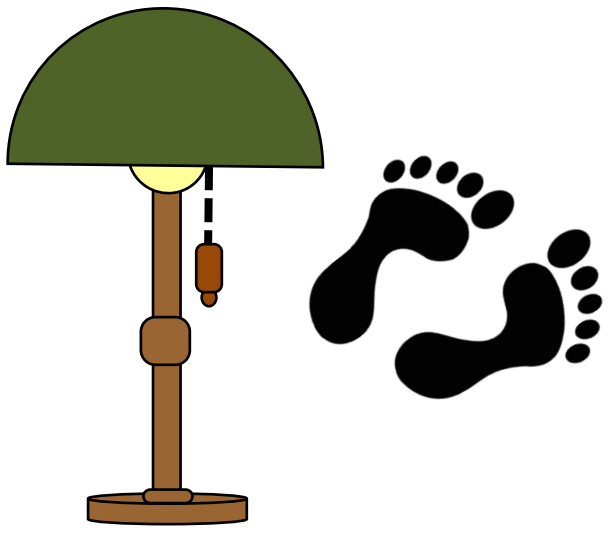

**Isaiah 55:10-11**

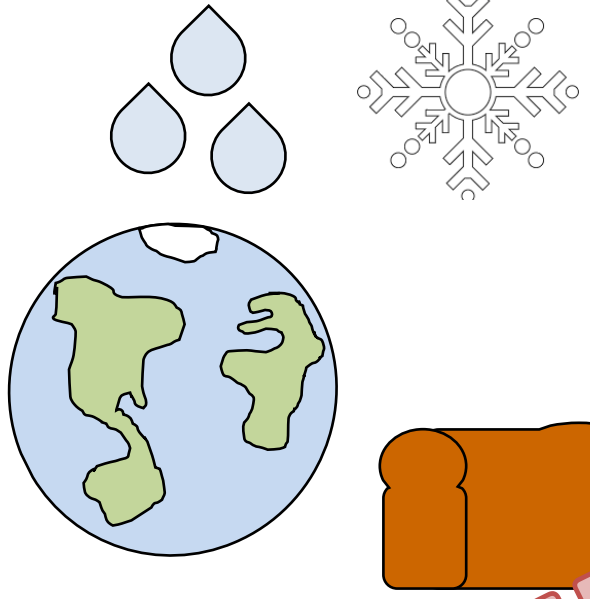

**Matthew 4:4**

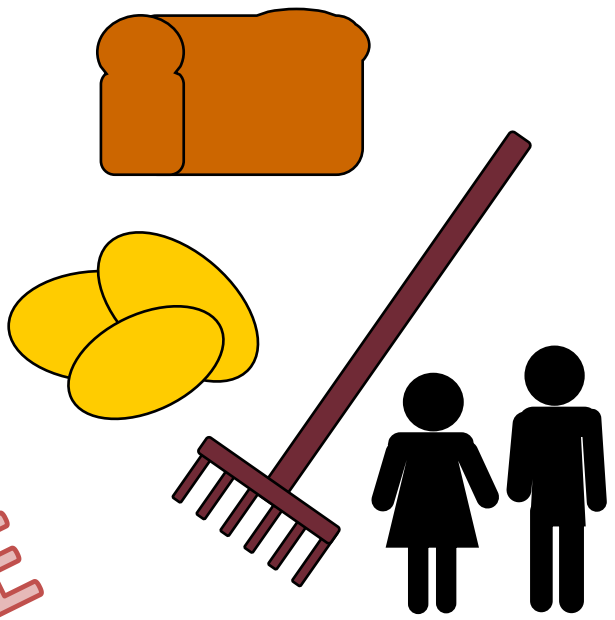

D&C  
14:2  
Two  
Edge  
Sword  
Scripture  
Activity

**1 Nephi 15:23**

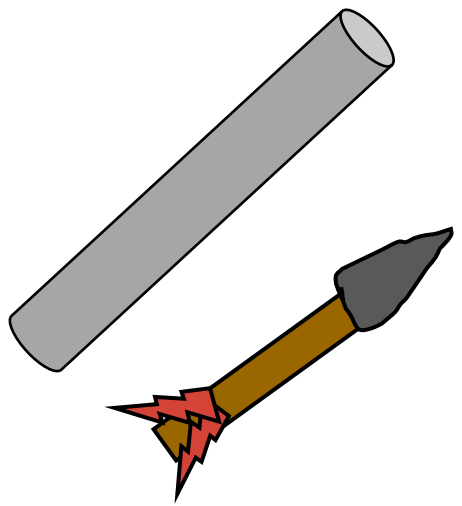

**Alma 32:28**

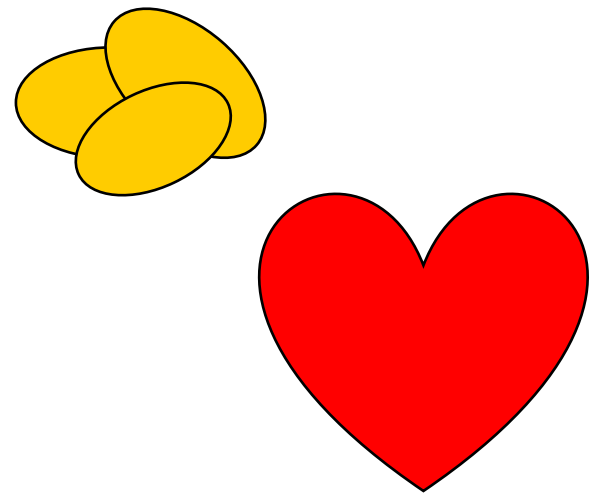

**D&C 14: 2**

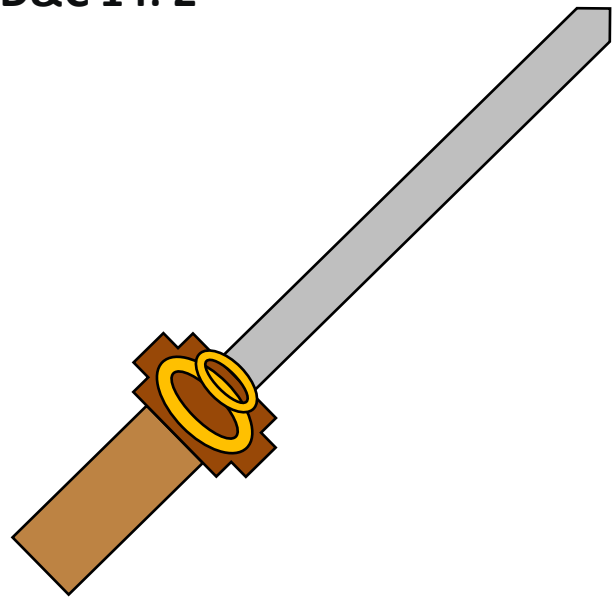

Circle Fun  
Coloring page  
included

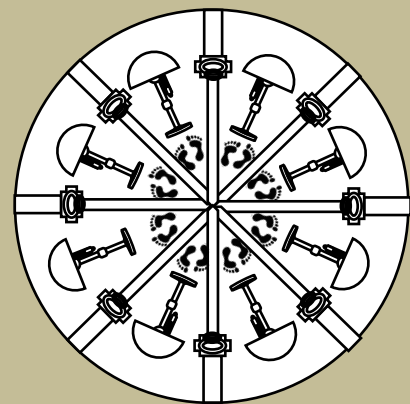

SAMPLE

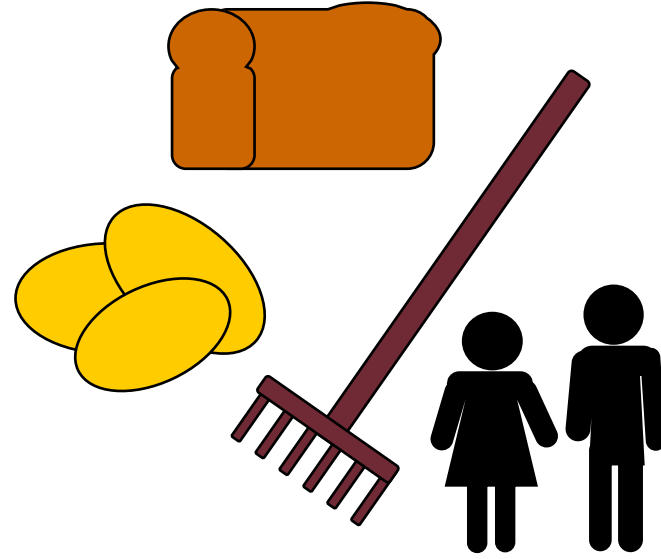
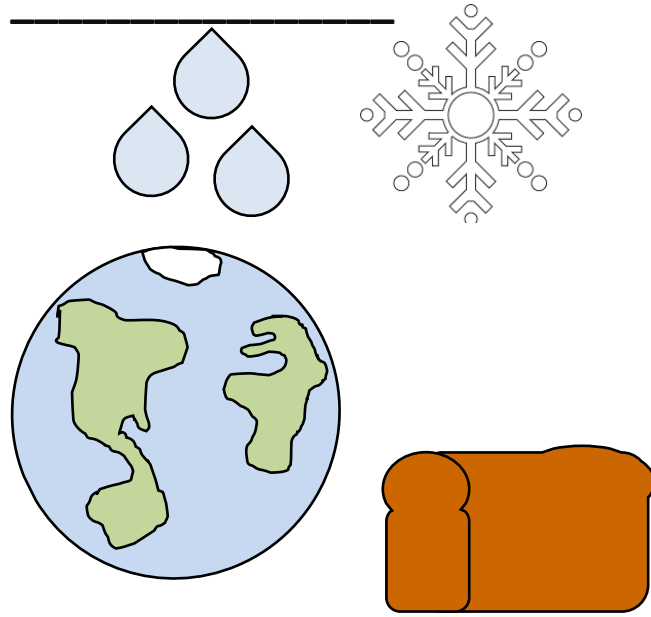

**D&C 14:2**

**Alma 32:28**

**1 Nephi 15:23-24**

**Isaiah 55:10-11**

**Matthew 4:4**

**Psalms 119: 105**

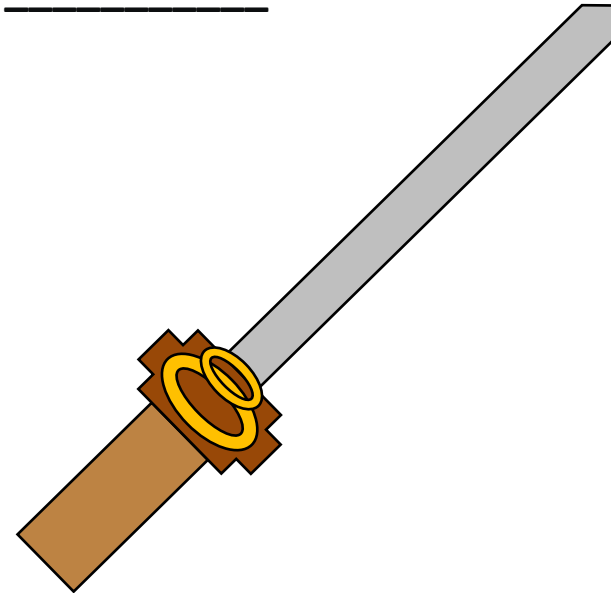
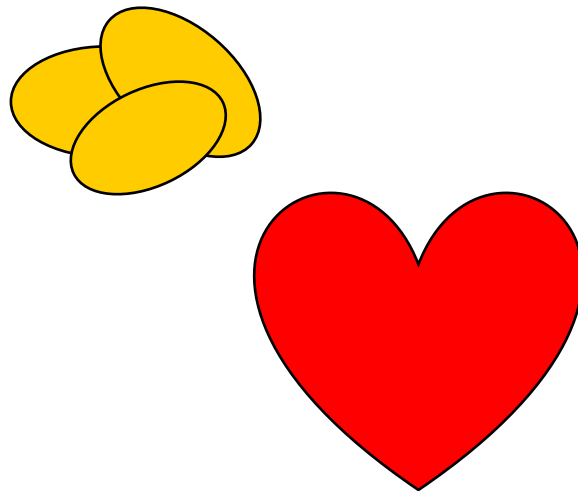
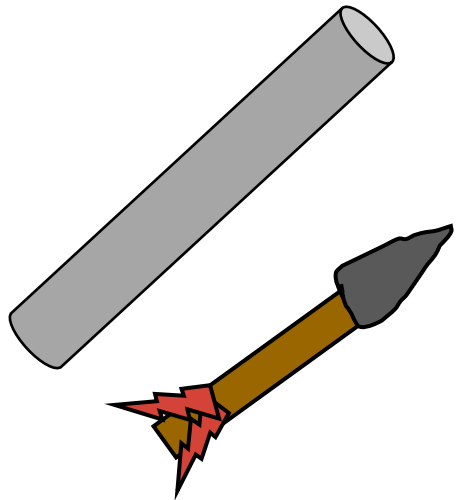

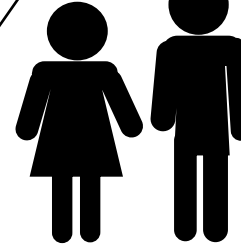
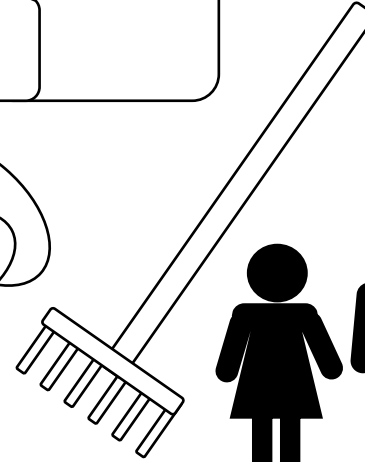
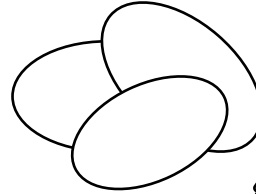
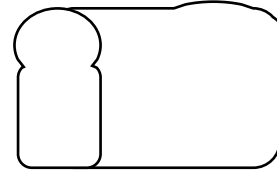
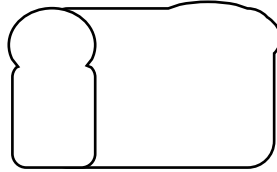
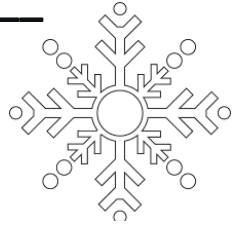
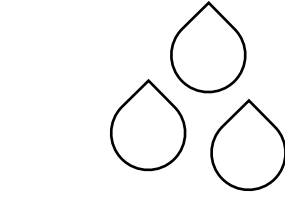
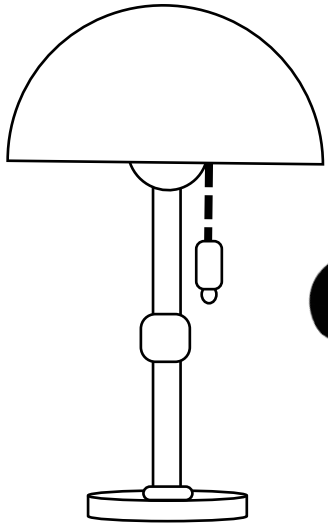

**D&C 14:2**

**Alma 32:28**

**1 Nephi 15:23-24**

**Isaiah 55:10-11**

**Matthew 4:4**

**Psalms 119: 105**

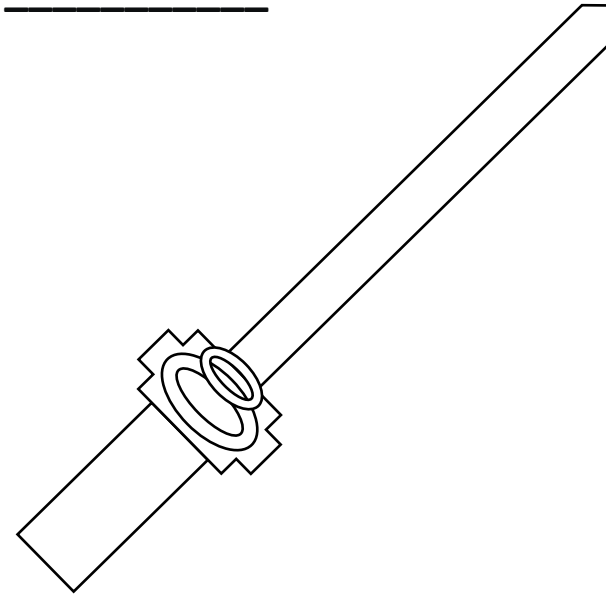
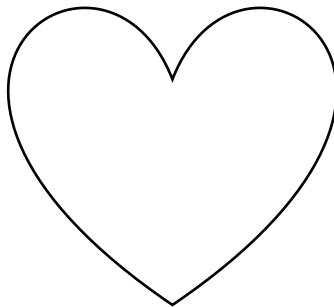
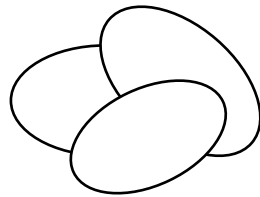
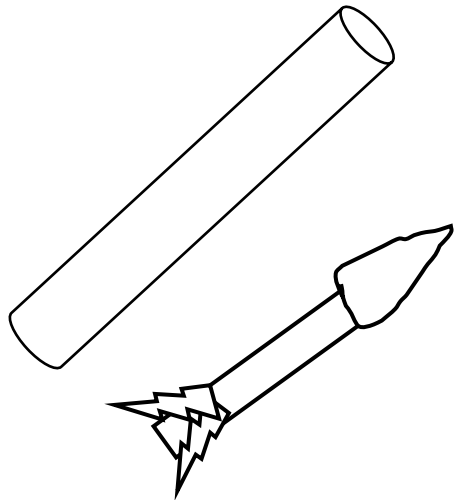

**Two Edge Sword**  
**D&C 14:2 and**  
**Psalms 119: 105**

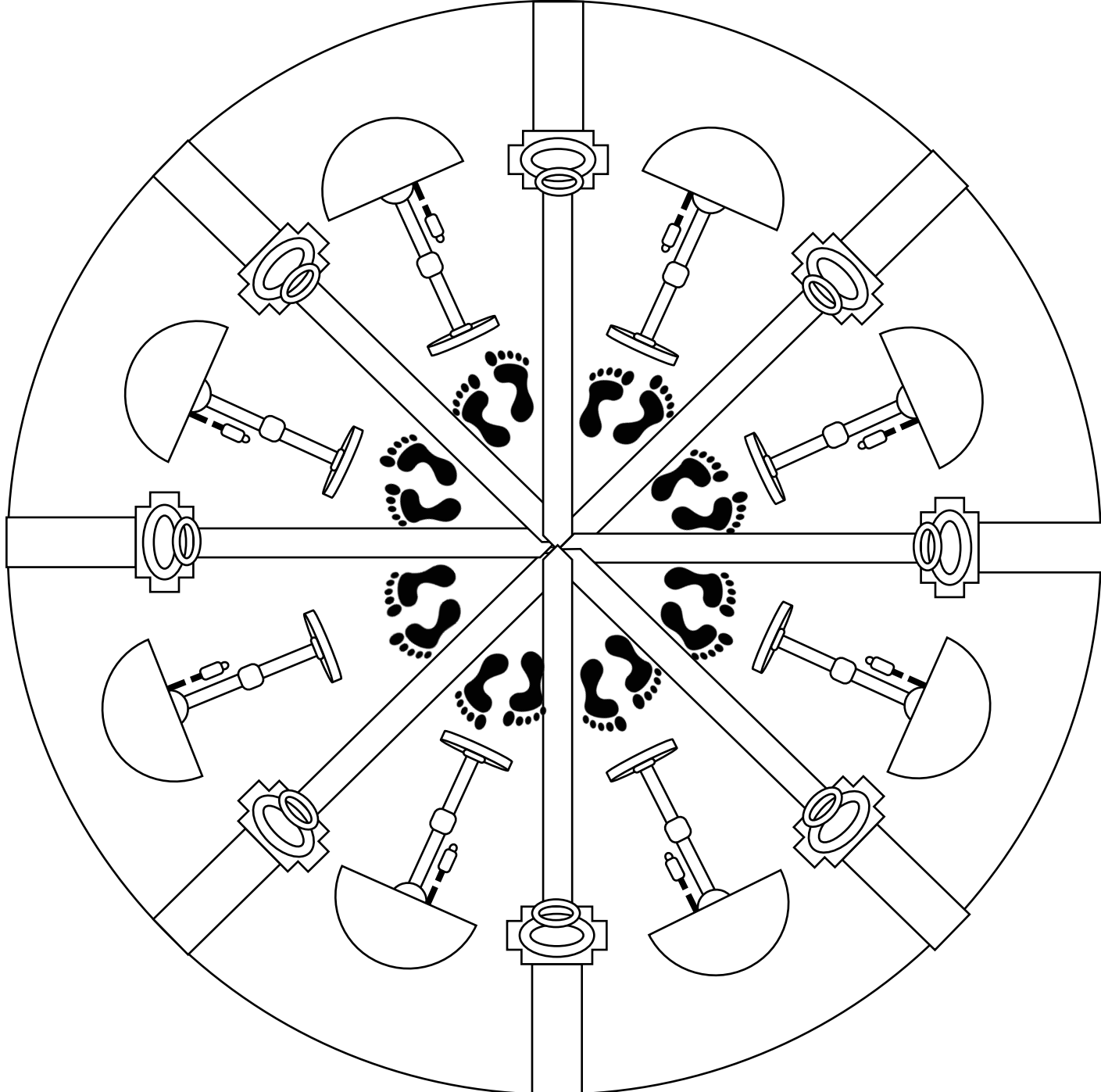

**D&C 14: 2** Behold, I am God; give heed to my word, which is quick and powerful, sharper than a two-edged sword, to the dividing asunder of both joints and marrow; therefore give heed unto my word.

**Psalms 119: 105** Thy word is a lamp unto my feet, and a light unto my path.

**Isaiah 55:10** For as the rain cometh down, and the snow from heaven, and returneth not thither, but watereth the earth, and maketh it bring forth and bud, that it may give seed to the sower, and bread to the eater:

**11** So shall my word be that goeth forth out of my mouth: it shall not return unto me void, but it shall accomplish that which I please, and it shall prosper in the thing whereto I sent it.

**Matthew 4:4** But he answered and said, It is written, Man shall not live by bread alone, but by every word that proceedeth out of the mouth of God.

**1 Nephi 15:23** And they said unto me: What meaneth the rod of iron which our father saw, that led to the tree?

**24** And I said unto them that it was the word of God; and whoso would hearken unto the word of God, and would hold fast unto it, they would never perish; neither could the temptations and the fiery darts of the adversary overpower them unto blindness, to lead them away to destruction.

**Alma 32:28** Now, we will compare the word unto a seed. Now, if ye give place, that a seed may be planted in your heart, behold, if it be a true seed, or a good seed, if ye do not cast it out by your unbelief, that ye will resist the Spirit of the Lord, behold, it will begin to swell within your breasts; and when you feel these swelling motions, ye will begin to say within yourselves—It must needs be that this is a good seed, or that the word is good, for it beginneth to enlarge my soul; yea, it beginneth to enlighten my understanding, yea, it beginneth to be delicious to me.

**Look up scriptures and Fill in scriptures on line page 2 or 3**