

*Includes Circle Fun Coloring Page*

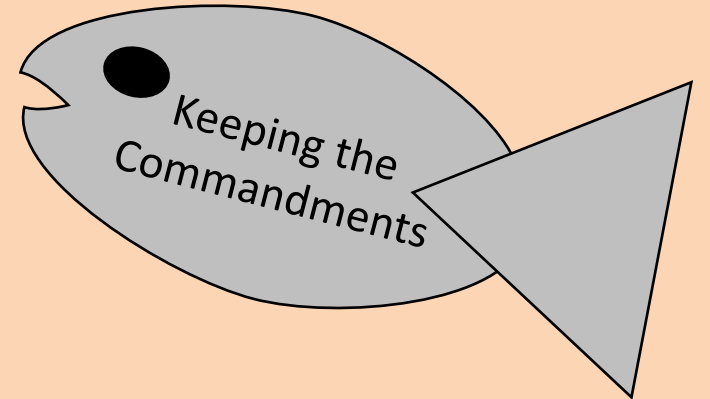

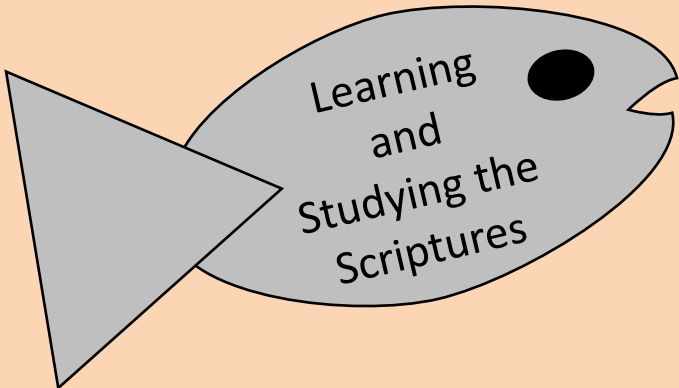

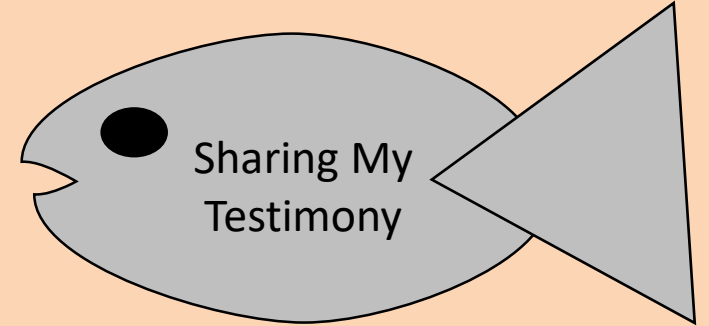

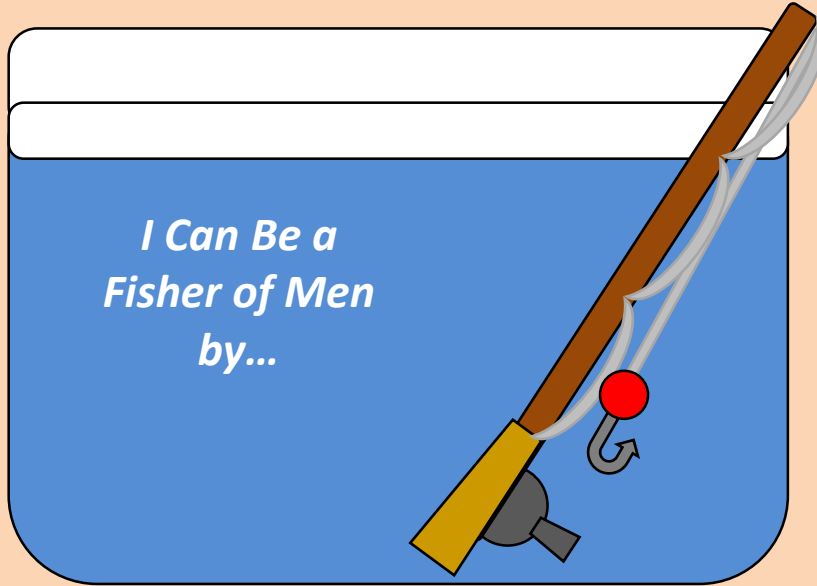
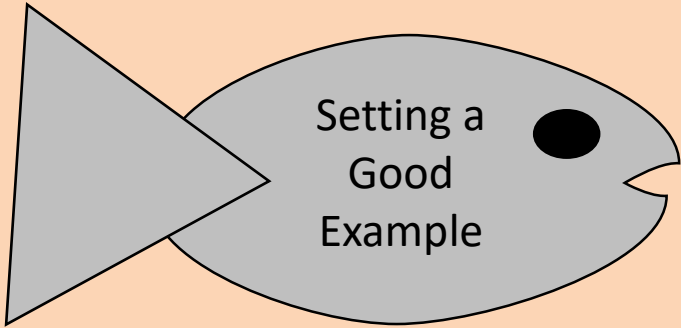
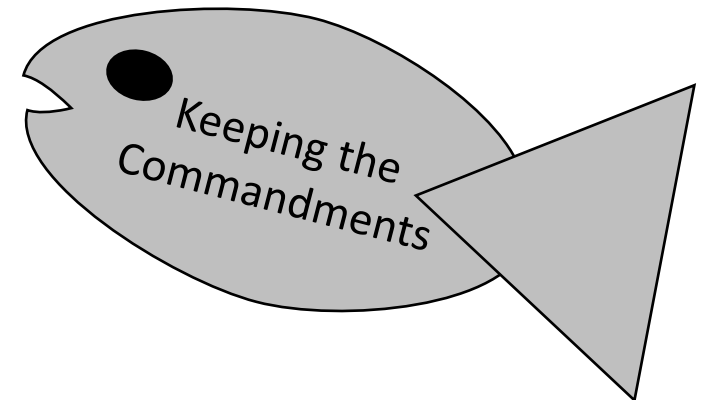
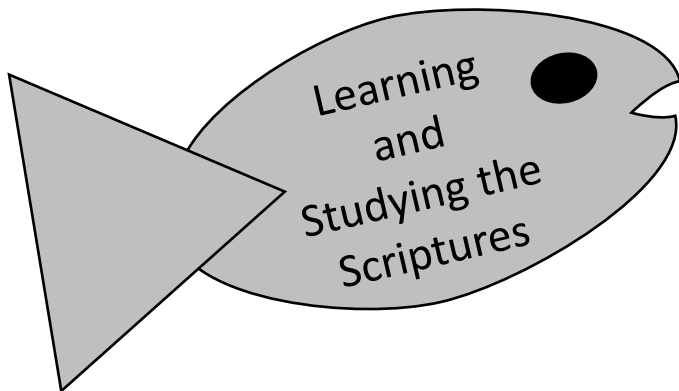
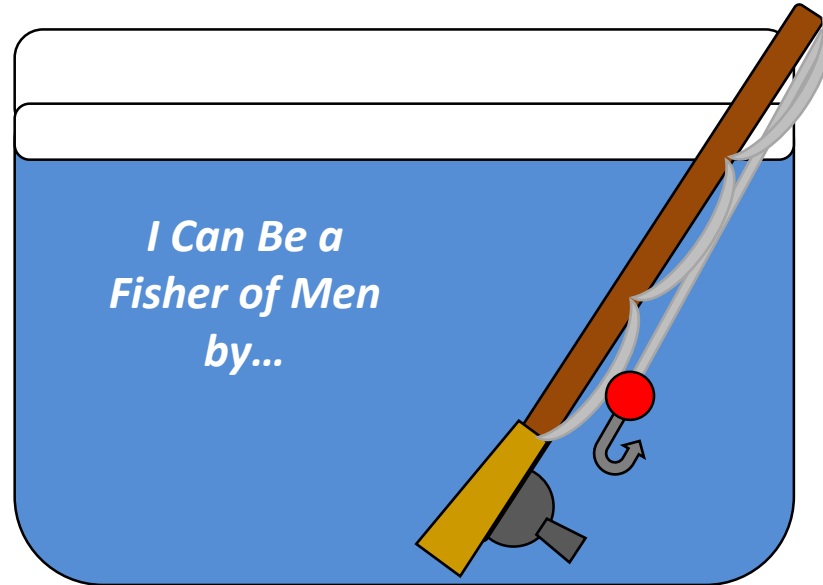
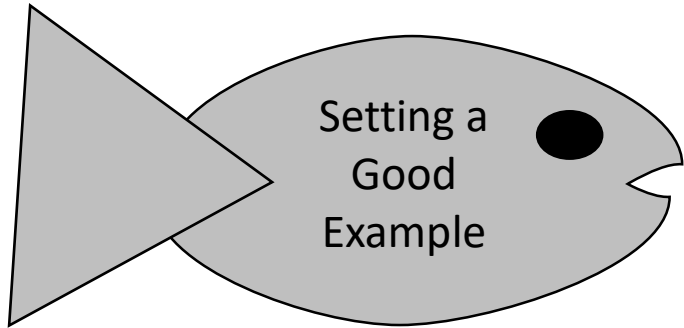
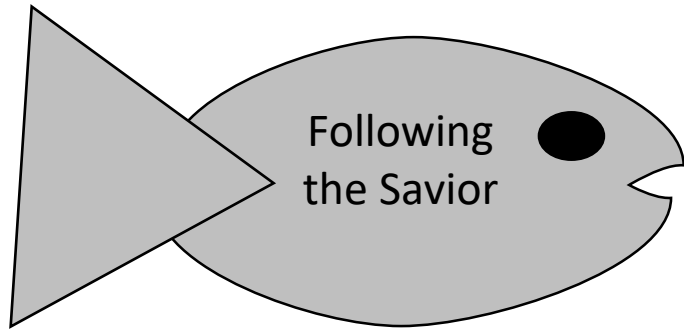
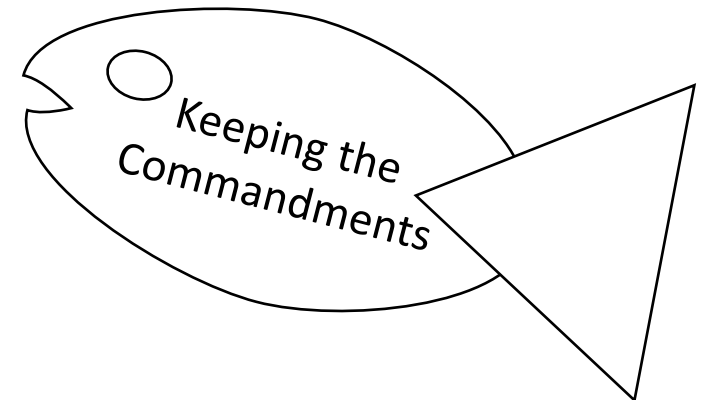
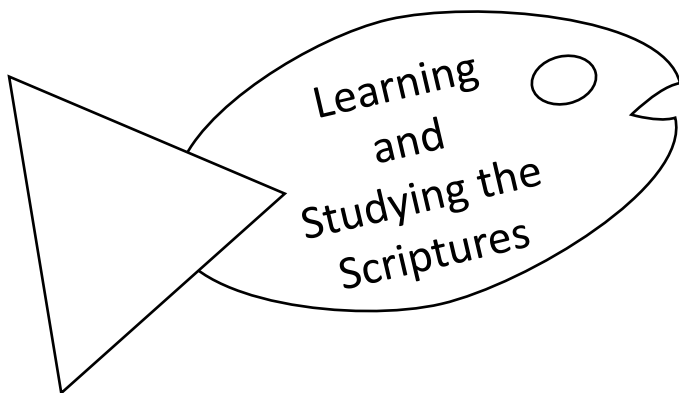
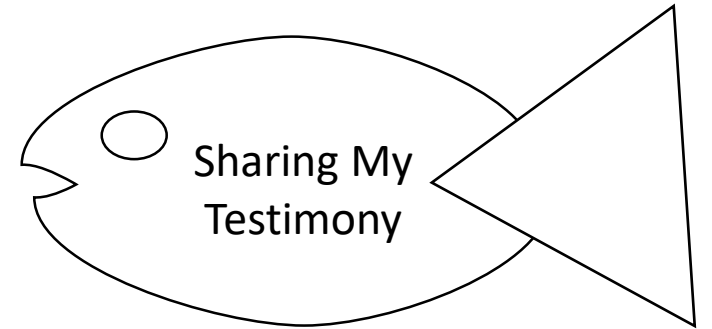
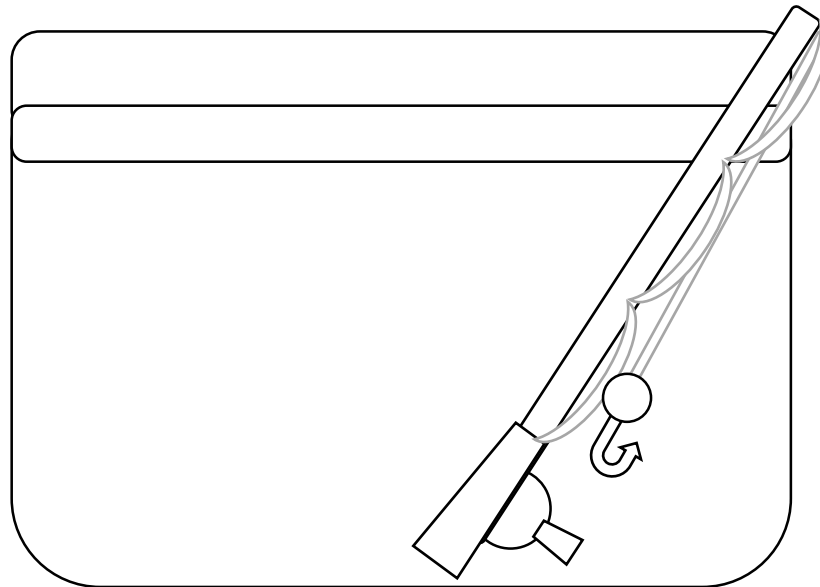
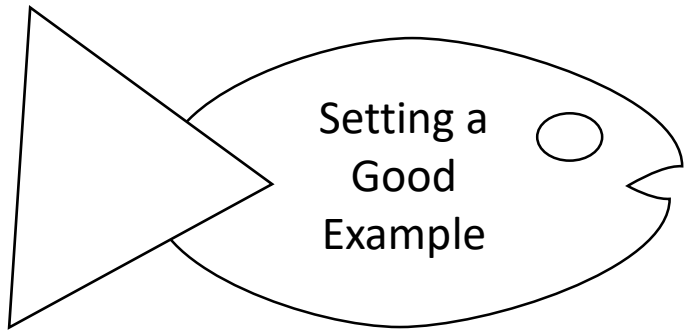
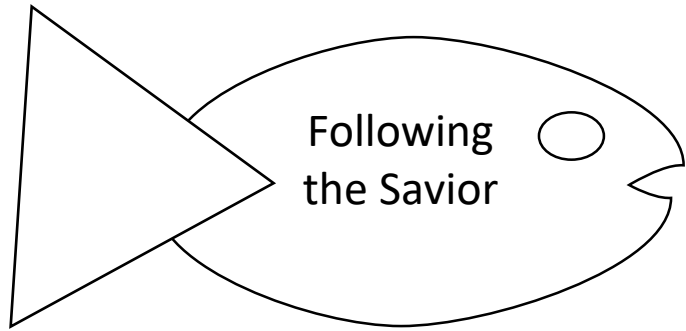
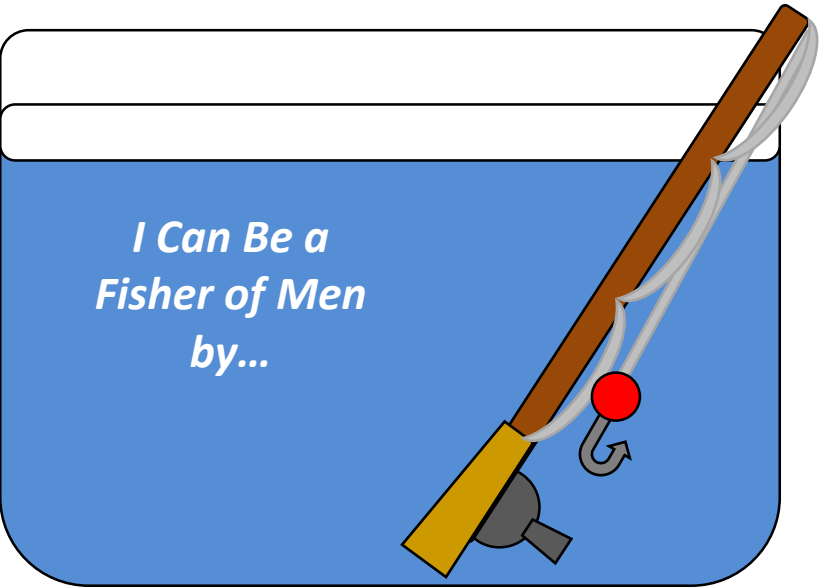

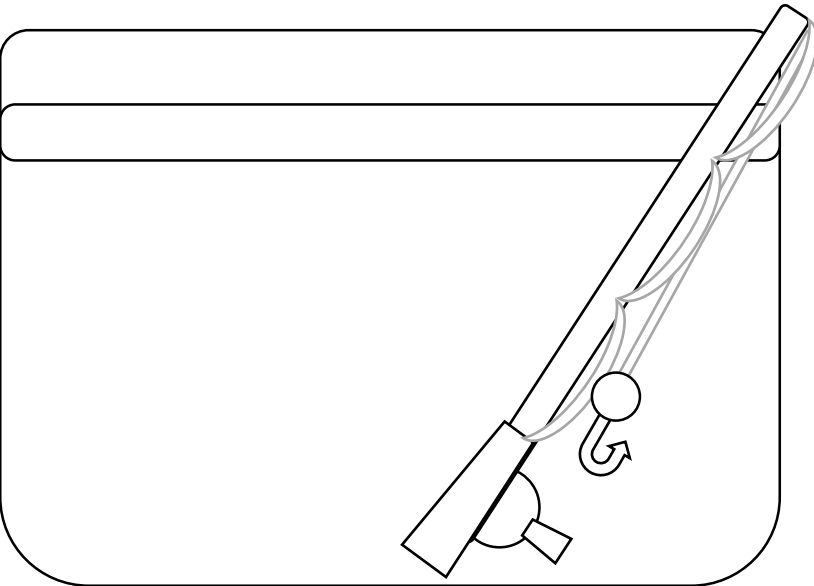

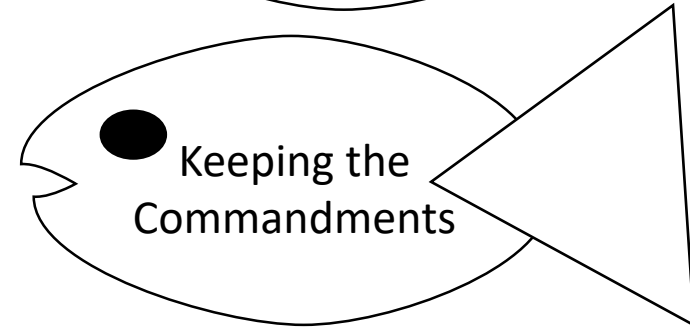
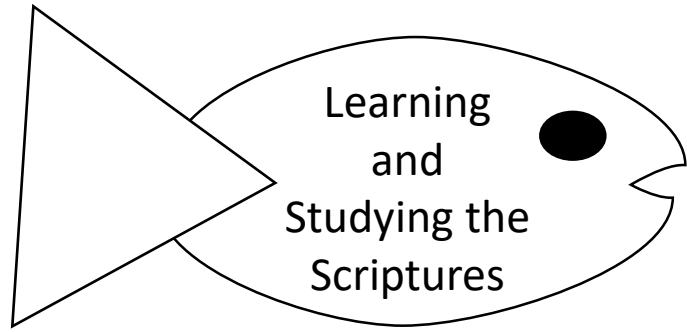
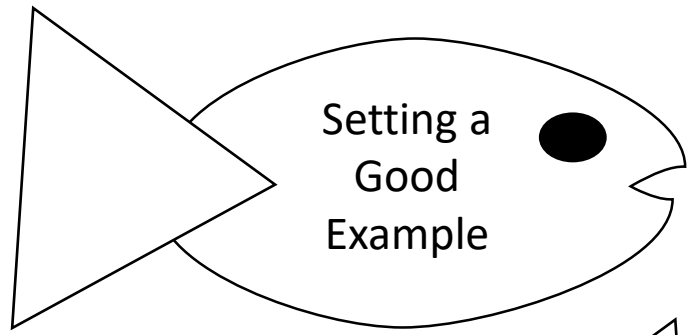
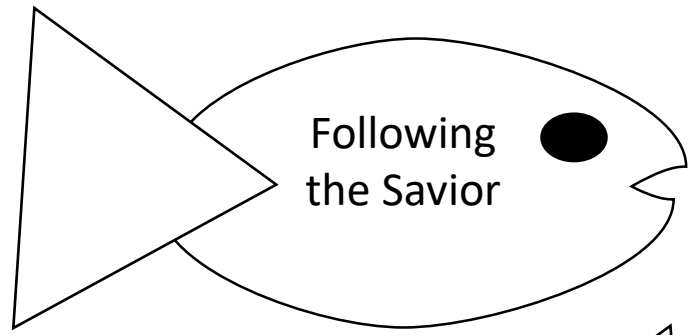

*Set of 2*

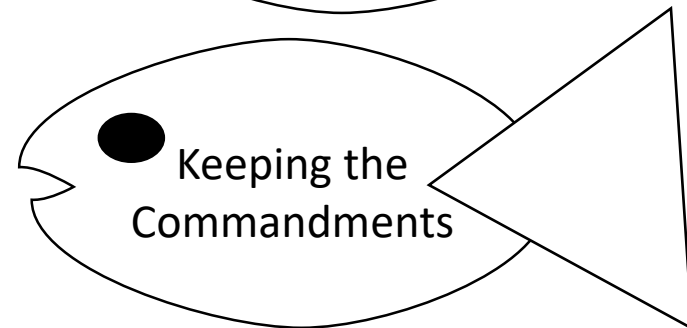
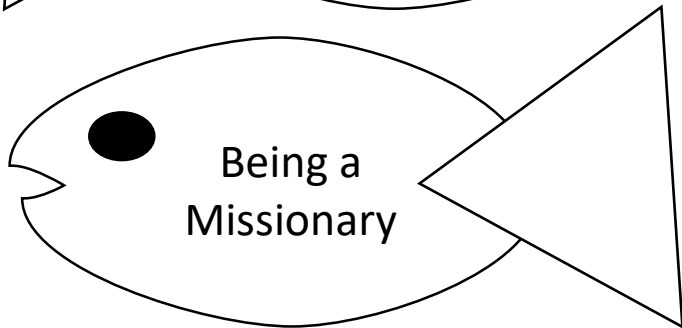
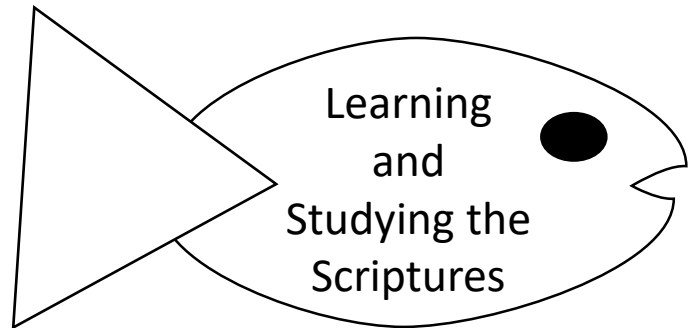
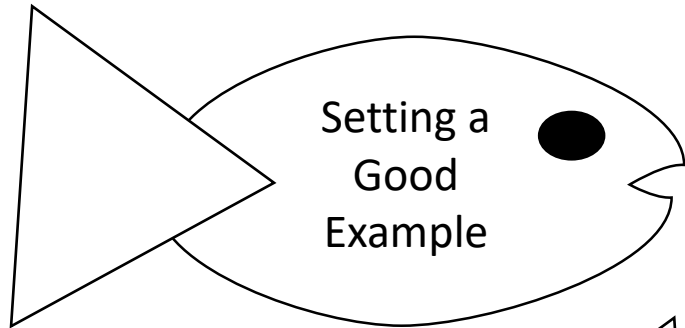
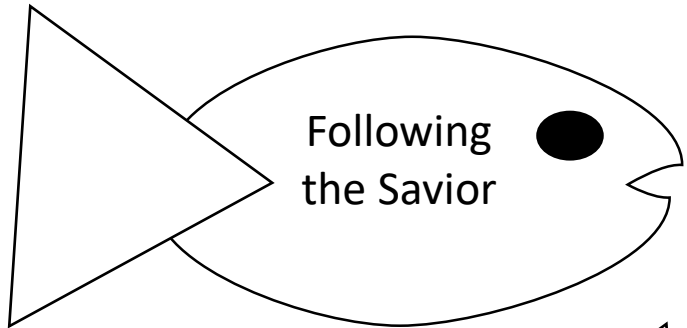

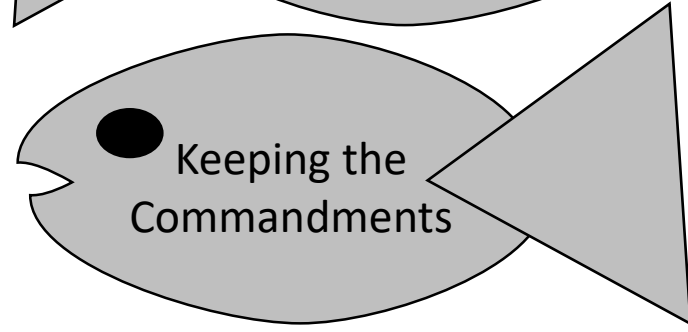
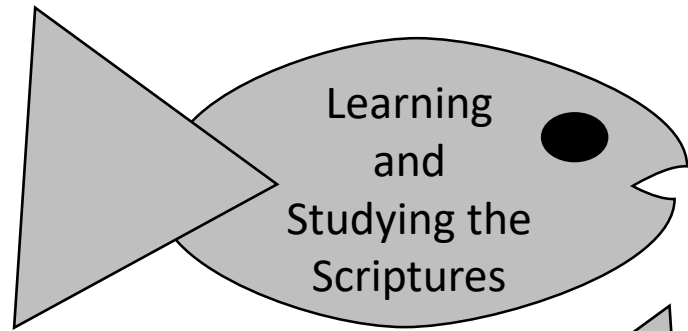
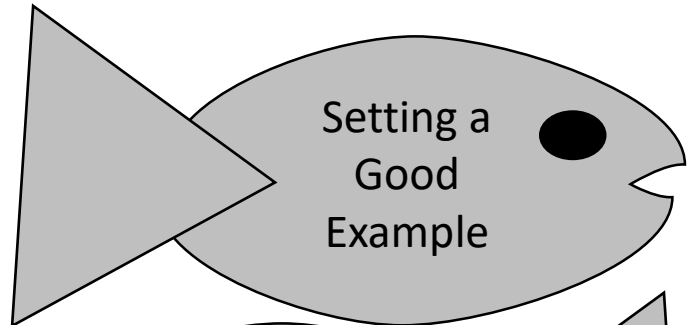
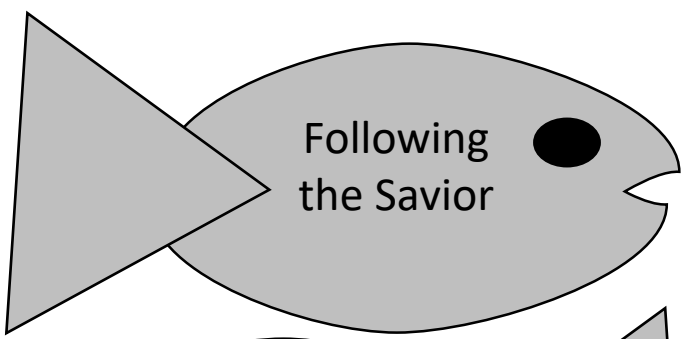

*Set of 2*

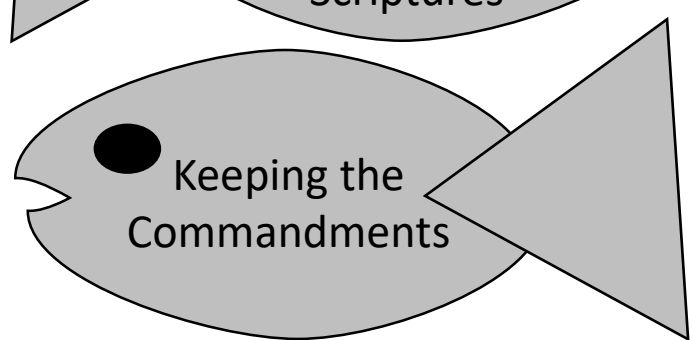
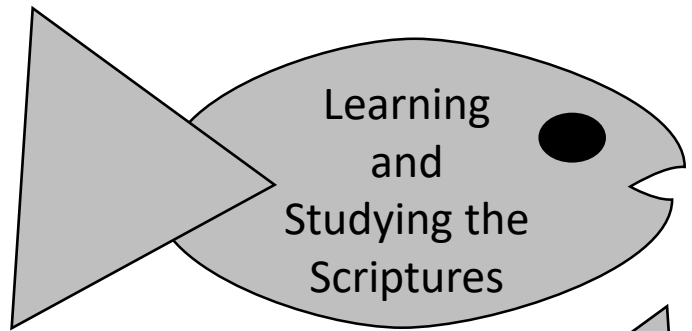
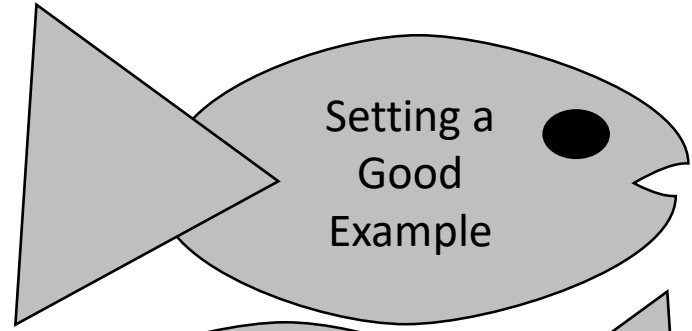
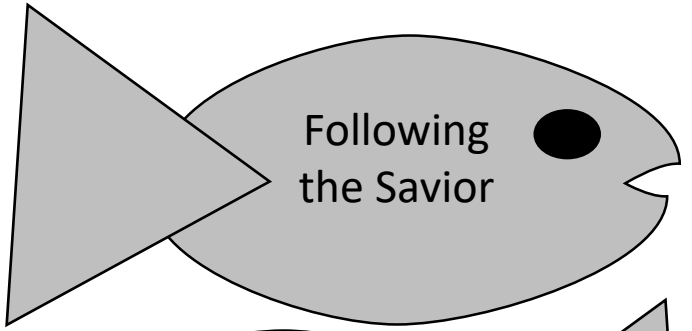















"I love fishing!" Jenny said as she helped her grandpa load their gear into the aluminum rowboat. "I'm glad that you're my fishing buddy," Grandpa replied with a wink. "It's good to have someone in the family who enjoys catching fish as much as I do."

Jenny and Grandpa pushed their little boat into the shallow water. Jenny climbed in and sat down in front. Grandpa took the seat in the back and shoved off with an oar. He handed the other oar to Jenny. Rowing was easy for Jenny and Grandpa. They had been on many fishing trips together and stroked smoothly without even thinking. It didn't take long to reach their favorite fishing hole. They pulled in their oars, and Grandpa dropped the anchor over the side. The splash threw cool lake water on Jenny. She giggled as she dried her face with her hands. The boat rocked gently on the rippled water.

"Let's get the fishing poles ready, Jen," Grandpa said. "You get the bait box."

Jenny squirmed. The one thing she didn't like about fishing was baiting the hook with a worm. "Grandpa, will you help me, please?" Jenny pleaded.

"I'll help you just this once," Grandpa answered. "But if you're going to be a real fisherman you have to learn to bait your own hook."

Jenny grinned. Grandpa said the same thing every time he put a worm on the hook for her. He helped Jenny cast her line way out into the sparkling lake. He baited his hook and cast over the opposite side. The line made a giant arch before the sinkers plopped into the water.

While they waited for a catch, Grandpa and Jenny talked softly so they wouldn't scare the fish. After a long while without even a tug on her line, Jenny announced, "The fish don't seem to be biting today!"

Grandpa nodded. "It reminds me of a New Testament story," he said. \*Peter was a fisherman too. He and his brother Andrew had a successful fishing business. They were partners with James and John, who were also brothers. They had been fishing all night, but their nets came up empty—not even one fish."

"I hope that doesn't happen to us," Jenny sighed.

Grandpa continued: "The following morning Peter, Andrew, James, and John were on the shore of Galilee cleaning and repairing their nets. Jesus Christ was teaching a crowd of people who had followed Him there. Jesus stepped into Peter's boat and asked him to push out from the shore. Jesus continued to teach the people from the boat. After His sermon was finished, He told Peter to launch out into the deep and cast his net that it might be filled."

"What did Peter do, Grandpa? He must have been tired of trying to catch fish."

"He told Jesus that they had been fishing all night with no success. But he and Andrew obeyed and lowered the net into the water. When they pulled it up, it was filled with fish! In fact, it was so full that Peter had to ask James and John for help so that the boat wouldn't sink. The fish filled their boat too."

"Wow!" Jenny exclaimed. "That was a miracle!"

"It was indeed," Grandpa agreed. "But that's not all. After the fishermen got back to shore, Jesus asked them to do something that took a lot more faith than dropping their net. He called each of them to leave all that they had and follow Him. Jesus said that He would make them fishers of men. They left everything and followed Him." "It would be hard to leave everything, Grandpa. I don't know if I could do that."

Grandpa nodded thoughtfully.

"What exactly does it mean to be a fisher of men?" Jenny asked.

"I believe it means to follow the Savior, to set an example, and to share our testimony and His gospel with others. I think those are things *these* fishermen can do." Grandpa pointed to himself and then to Jenny. Jenny smiled. "Thanks, Grandpa. I like that story."

"It's a good one," Grandpa replied. "There are always great lessons for us in the scriptures."

Jenny sat quietly. She knew that there was nothing to do now but be patient. She was quiet as she waited for a tug on her line.

"What are you thinking about, Jen?" Grandpa asked, interrupting the silence.

"I was just thinking that it's OK if we don't catch any fish today. After all, there's more than one way to be a fisherman."

# Fishers of Men

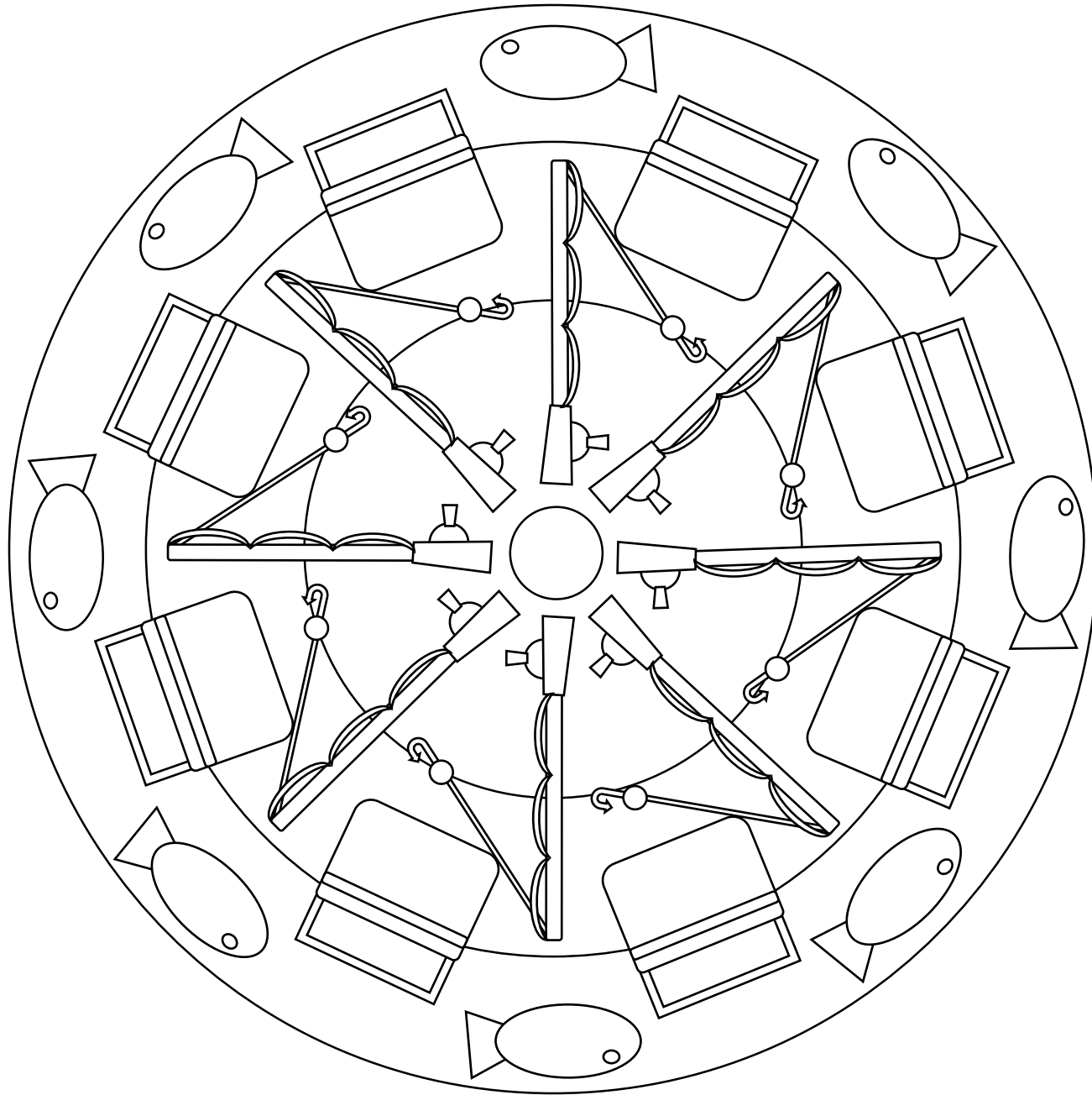

Instructions:

Read the Story “The Fishermen” by Wendy Ellison

You can use pictures by downloading them on your tablet.

I download the video “Follow Me, and I Will Make You Fishers of Men.

<https://lds.org/bible-videos/videos/follow-me-and-i-will-make-you-fishers-of-men?lang=eng>

Instead of the grandfather telling the story use the video.  
Or you can use the pictures provided.

Activity:

Page 2: Handout

Page 3: Coloring Handout

Page 4 and 5 Cut and Paste background for Page 6 or 7

Page 6 and 7: Cut fish and paste on background of page 4 or 5

Page 8-13 Story of Fishermen

Page 14: Story “The Fishermen

[https://www.lds.org/friend/2006/08/the-fishermen?lang=eng&\\_r=1](https://www.lds.org/friend/2006/08/the-fishermen?lang=eng&_r=1)

Page 15: Circle Fun Coloring Page